

NU-VISTA SERIES

by

MUSICAL FIDELITY

DESIGNED IN ENGLAND

Installation Guide

NU - VISTA

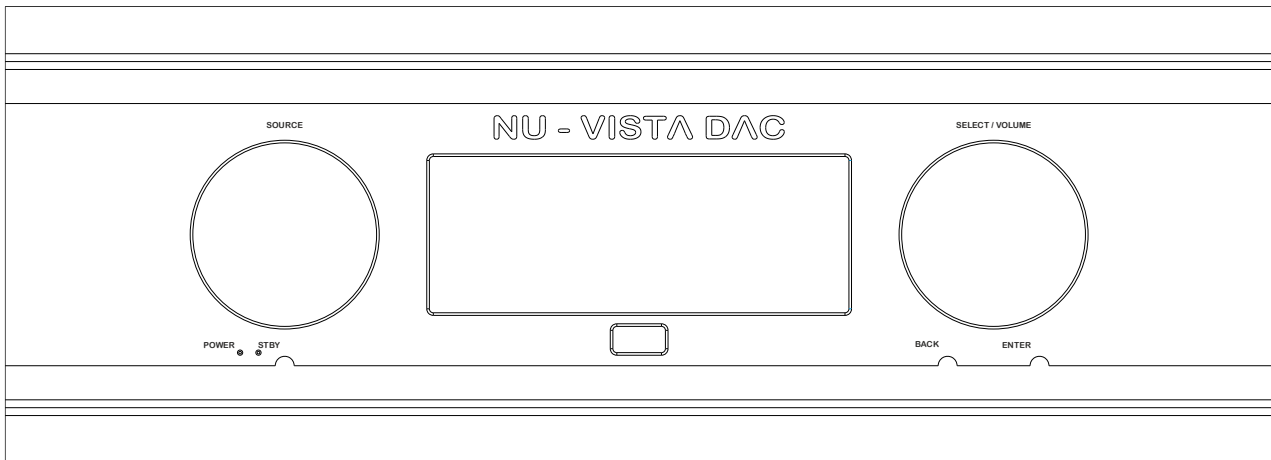

Instructions for use

Thank you for purchasing the Nu-Vista DAC by Musical Fidelity. Based on our excellent nuvistor tube technology, we decided to go all out “fully balanced” on the Nu-Vista range.

The Nu-Vista DAC is our new flagship DAC built around the critically acclaimed ESS 32-bit HyperStream II DAC architecture. It features RCA and XLR outputs, 3x optical and 1x coax SPDIF inputs, 1x USB and 1x AES/EBU inputs. A I2S input is also there, for a future yet to be announced Nu-Vista CD-player!

Building on our knowledge and experience with Sabre ESS chips, the Nu-Vista DAC uses 2x ES9038Q2M chips in dual differential mode for a pristine dual mono design. The inclusion of a Time Domain Jitter Eliminator results in superb SNR and THD+N performance with unbelievably detailed transient response. Other advances in the DAC section include optional upsampling and re-clocking and an oversampling bypass mode. The 16-core X MOS and CPLD MAX II Altera processors ensure there is always enough headroom for these operations, the digital filters, including our own new proprietary filter for optimum transient response, and the MQA processing.

Optionally, the Nu-Vista DAC can be powered by the Nu-Vista Uni PSU (set to be released in 2024). This will achieve better noise performance, by moving the AC mains power supply from the main unit and build it into another matching box. We are taking advantage of the extra space to set up mains and output filtering a step above what is usually possible in one-box-solutions.

Also included is the Nu-Vista remote control which is a solid “Nu-Vista” style re-imagination of usual remote controls. Machined from solid, it has the same feel as the front panel of the unit, has a powerful beam, and runs off easily replaceable AAA batteries.

Used properly and carefully, it should give many years of outstanding musical reproduction. Dust regularly with a soft duster or soft brush, but be careful when using cleaning or polishing agents - they may harm the surface finish.

If there are any questions about the audio system, please consult the dealer, who is there to help and advise.

CUTAWAY VIEWS

Showing Cylindrical Electrodes and Tripod-Like Supports

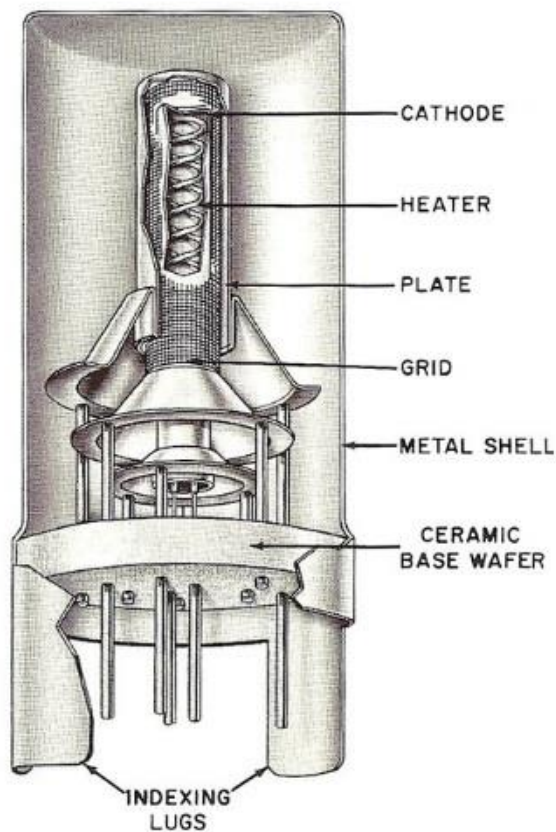

Typical
Single-Ended
Nuvistor Triode

** UK English "valve" mentioned hereafter, refers to the 'electron valve' kind, also known as electron "tube" in other parts of the world.*

**Section
Page**

Safety Information	– Mains plug (UK only), modification warning	4
General advice	– Installation precautions	5
Installation	– Introduction, cleaning, installation, power connections, audio connections, spike feet	6
Facilities and connections	– Illustrations, front & rear panels	8
Remote control handset	– Operation and illustration	9
Operation	– Starting – Input Selection – Menu Navigation – Main View – Nuvistor LED Indicator Line – Audio Formats – Sample Rate – Digital Oversampling FIR Filter – Input – Volume – Reclocking – Upsampling – Bit Depth – System Settings – Digital Filters	10
Problems?	– Troubleshooting	15
Specifications	– Product specifications	16
Manual history		
Item disposal information		17

IMPORTANT! (U.K. only)

This unit is supplied in the U.K. with mains lead fitted with a moulded 13 amp plug. If, for any reason, it is necessary to remove the plug, please remove the fuse holder and dispose of the plug safely, out of reach of children.

It must not be plugged into a mains outlet.

The wires in the mains lead supplied with this appliance are coloured in accordance with the following code:

Green and yellow	Earth
Blue	Neutral
Brown.....	Live

WARNING – This appliance MUST be earthed

As the colours of the wires of the mains lead of this appliance may not correspond with the coloured markings identifying the terminals in the plug, proceed as follows:

- The wire which is coloured green-and-yellow must be connected to the terminal in the plug which is marked with the letter E or coloured green or green-and-yellow, or by the earth symbol: 
- The wire which is coloured brown must be connected to the terminal which is marked with the letter L or coloured red.
- The wire which is coloured blue must be connected to the terminal which is marked with the letter N or coloured black.
- If connecting to a BS1363 plug, a 13 amp fuse must be used.

WARNING:
ANY MODIFICATIONS TO THIS PRODUCT NOT EXPRESSLY APPROVED BY MUSICAL FIDELITY WHO IS THE PARTY RESPONSIBLE FOR STANDARDS COMPLIANCE COULD VOID THE USER'S AUTHORITY TO OPERATE THIS EQUIPMENT.

Installation, Precautions & User Information

This new Nu-Vista DAC is designed and built to provide trouble-free performance, but as with all electronic devices it is necessary to observe a few precautions:

- Heed all warnings shown on the back of the product.
- Only connect the Nu-Vista DAC to a mains outlet having the same voltage as marked at the back of the unit.
- Always ensure that when disconnecting and reconnecting your audio equipment the mains supply is switched off.
- Position the mains lead and signal interconnects where they are not likely to be walked on or trapped by items placed on them.
- Do not use near water, or place water-filled containers on the Nu-Vista DAC, for example, a flower vase or potted plants. **If water does spill inside, immediately pull out the mains plug from the wall socket and inform your dealer, who should then check the unit before further use. Entry of liquid into the Nu-Vista DAC is dangerous, and may cause electric shock or fire hazard.**
- Do not place the unit near direct heat sources such as radiators, direct sunlight or other equipment.
- Do not remove any covers or try to gain access to the inside. There are no internal adjustments or fuses you can replace yourself. Refer all service work to an authorised Musical Fidelity agent.
*** Note: Unauthorised opening of the equipment will invalidate any warranty claim.**
- Dust regularly with a soft cloth or soft brush but be careful when using cleaning or polishing agents - they may harm the surface finish.

The electronics in modern hi-fi equipment is complex and may, therefore, be adversely affected or damaged by lightning. For protection of the audio system during electrical storms, remove the mains plugs.

If after-sales service is required, to help the dealer identify the Nu-Vista DAC please quote the serial number located on the rear panel of the unit.

Introduction

Congratulations on the purchase of the new Nu-Vista DAC. Great attention has been paid to internal layout, isolating each circuit section to prevent possible interaction. The unit features a finely tuned and tweaked Nu-Vista valve design, for smooth sound coupled with low noise and virtually no distortion.

This unit will deliver the ultimate performance possible from any digital source. It is designed to upgrade CD players, TVs, set-top-boxes, DAB tuners, USB Streamers and PCs and Laptops and any other source providing a variety of digital outputs.

Cleaning

Before cleaning the unit, switch off power at the mains switch and remove the mains plug from the wall socket. Clean the cabinets using a moist cloth. Using solvents, white spirit or thinners is not advised, as they could damage the surface finish.

Setting up

Position the Nu-Vista DAC on a stable, horizontal surface where there is no risk of it being knocked. Make sure ALL units involved are switched off and unplugged from mains supply before making or removing any connections.

Important note:

During normal operation, the unit dissipates an appreciable quantity of power at all times, and it is important that it is well ventilated. The top and bottom are perforated to allow the smooth flow of heat through the unit. However, the unit must not be enclosed in a cabinet or placed where the ventilation holes are impeded as this could result in excessive heat build-up.

The Nu-Vista DAC must be protected from humidity – if the unit is moved from a cold place to a warm room, leave the unit for an hour or so to allow sufficient time for the moisture to evaporate.

Power Connections

The Nu-Vista DAC is supplied with a standard IEC mains cable which plugs into the IEC socket at the back of the unit.

Upgrade power connection:

Optionally, the Nu-Vista DAC can be powered by the Nu-Vista Uni PSU (set to be released in 2024) via the PSU RH Power, LH Power and Control connections. Please refer to the Nu-Vista Uni PSU manual for details.

Audio Connections

Outputs: The Nu-Vista DAC has a single ended RCA line level and a balanced XLR line level output. Both can be used simultaneously.

RCA audio output: Use good quality RCA phono audio cables (fully connected signal and ground), for optimum signal transfer.

XLR audio output: Use good quality XLR audio cables (fully connected hot and cold signals and ground), for absolute optimum signal transfer.

Digital Input Connections

COAXIAL input: Connect RCA digital source to digital input RCA socket. Use a good quality fully connected (signal and ground) coaxial digital cable, for optimum signal transfer.

OPTICAL inputs: Connect optical digital source to optical input socket. Use a good quality "Toslink" cable, for optimum signal transfer.

USB input: Connect computer or similar USB "host" source to USB input socket. Use a good quality USB 2.0 type cable (not supplied), for optimum signal transfer. Try to keep USB cable length to a minimum for best reliability. The USB standard maximum for a single cable is 5M, after which repeaters (normally mains-powered USB hubs) are required. We do however; recommend avoiding such a setup if at all possible.

AES/EBU input: Connect a balanced AES/EBU source to digital input XLR socket. Use a good quality XLR cable, specifically designed to carry digital signals and not XLR cables for analogue audio transmission!

I2S input: Use a good quality HDMI cable to connect the upcoming (released in 2024) Nu-Vista CD.

NU - VISTA DAC

Trigger Input and Output

Triggering input and outputs are available to allow the DAC to be turned on automatically by other equipment or turn on other equipment automatically when the Nu-Vista DAC is turned on. This is a 2-way 3.5mm jack on the back of the unit labelled "TRIGGER". It requires 5 to 12V (either polarity) to switch the DAC on.

Mounting optional Spike Feet

The Nu-Vista DAC can optionally be used with spike feet. We recommend to ask a second person to help you lift the Nu-Vista DAC for mounting the feet or felt pads.

If you want to use the standard mounted feet, you can attach the big felt pads to those feet (remove the small rubber feet first if necessary).

To mount the spike feet, screw the threaded rods into the spike feet so that the allen key side is inside the foot (this way, when you want to remove the foot from the amplifier again, you can unscrew the foot and then unscrew the threaded rod from the amplifier with an allen key, should it be too tight to unscrew by hand). Then screw the feet into the amplifier (remove the small rubber feet first if necessary). Attach the small felt pads to the bottom of the spike feet cups and place these cups under the spike feet.

XLR Balanced input and output lead connections:

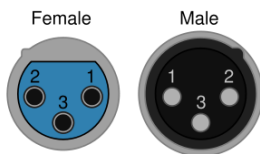

(for reference, no XLR signal leads supplied)

Pin functions:

- | | |
|---|-----------------------------------|
| 1 | Ground (cable shield) |
| 2 | Normal polarity ("hot" or "+") |
| 3 | Inverted polarity ("cold" or "-") |

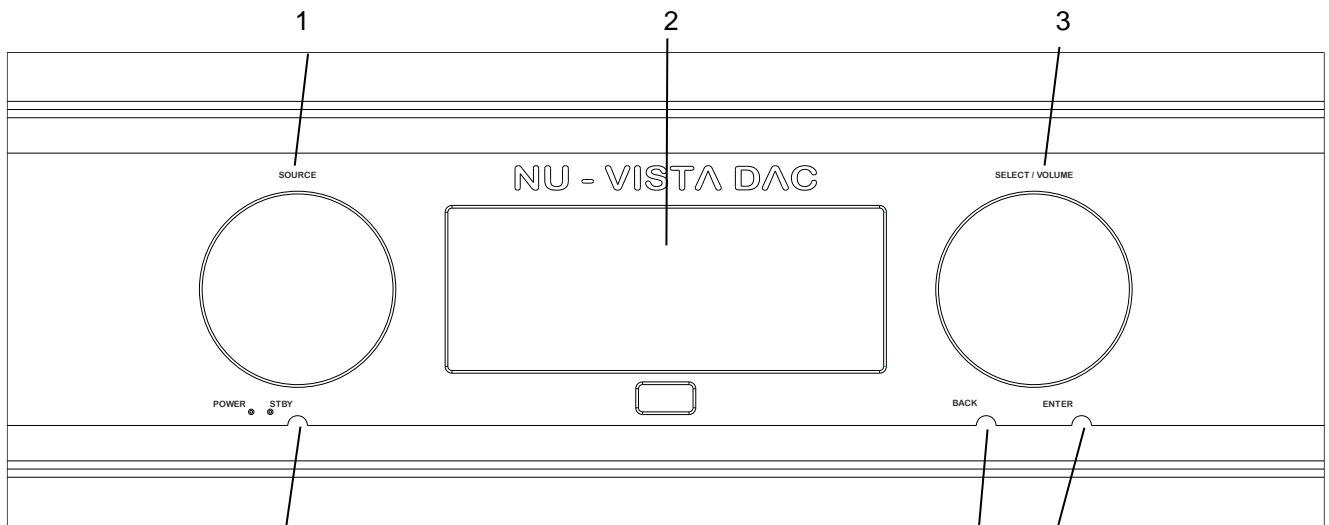

- | | |
|-------------------------------|---------------------------------|
| 1 INPUT selector | 4 POWER / STANDBY button |
| 2 DISPLAY | 5 BACK button |
| 3 Menu/VOLUME selector | 6 ENTER button |

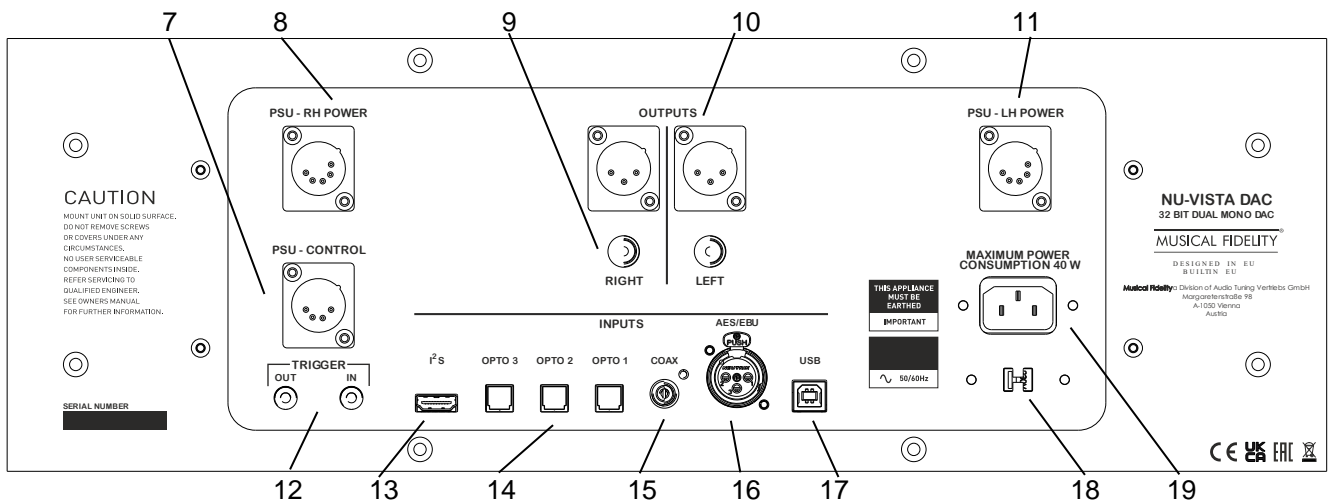

- | | |
|---|-------------------------------------|
| 7 PSU – CONTROL optional power input | 14 OPTICAL SPDIF inputs |
| 8 PSU – RH POWER optional power input | 15 COAXIAL SPDIF input |
| 9 RCA SINGLE ENDED output | 16 AES/EBU input |
| 10 XLR BALANCED output | 17 USB Audio Class 2.0 input |
| 11 PSU – LH POWER optional power input | 18 230/120V selector |
| 12 TRIGGER output and input | 19 MAINS IEC socket |
| 13 I2S input for upcoming Nu-Vista CD (released later in 2024) | |

NU - VISTA DAC

The universal remote control shown below enables functions from this and related units to be operated from a convenient distance.

Equivalent buttons on the remote control have the same functions as those on the front panel of the unit. Other functions are only available by remote control.

As the handset uses an invisible infra-red light beam, the front edge must be pointed directly towards the receiver window at the front of the player, without visual obstruction between them.

If the range of the remote control greatly decreases, replace the batteries with new ones. Do not mix old and new batteries – two are required, size AAA, LR03 or SUM-4.

Please dispose of used batteries in accordance to local regulations.

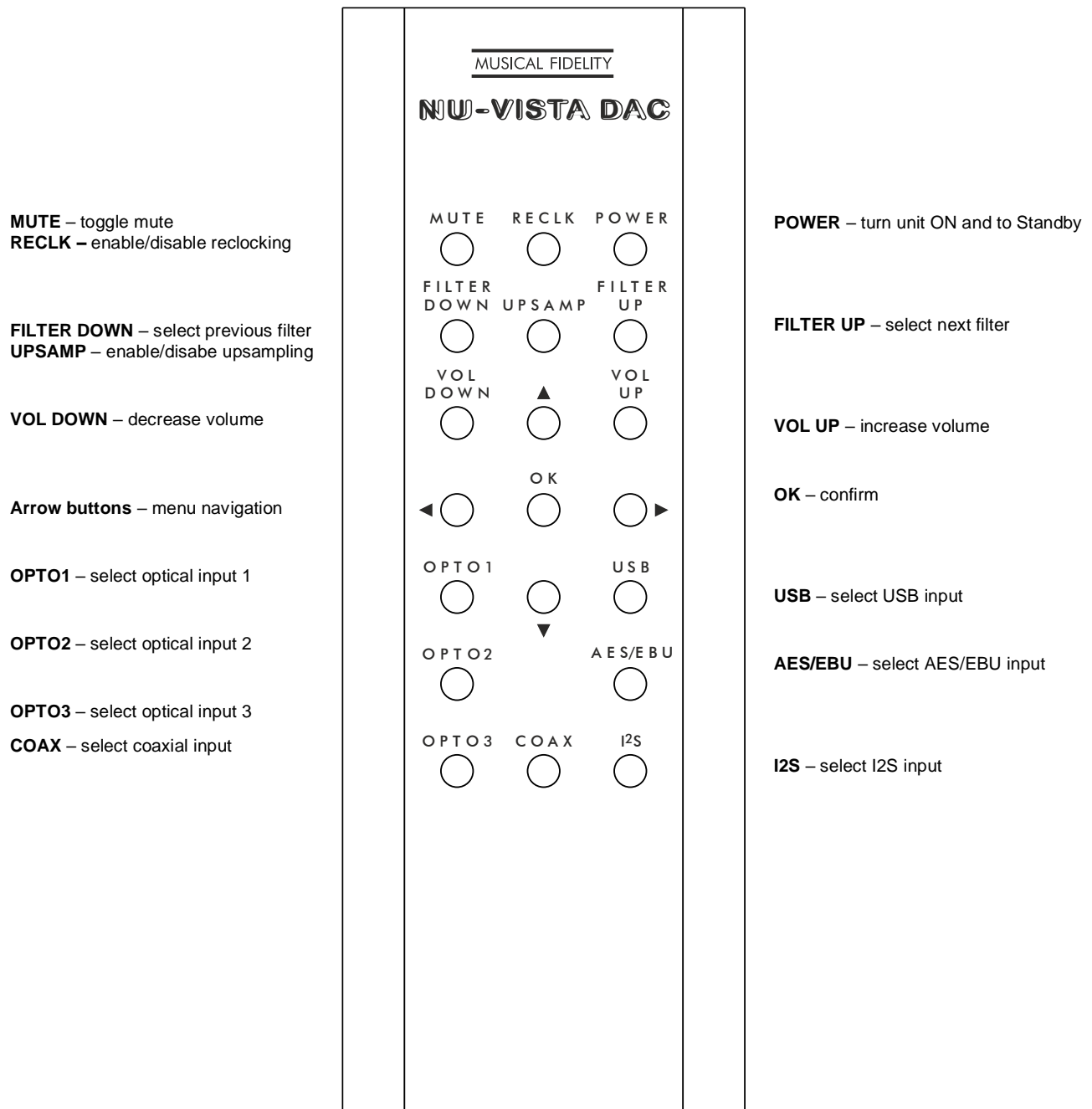

Starting

Once the Nu-Vista DAC unit is correctly wired up, and plugged into mains, the **Standby LED** will light up. In this mode the Nu-Vista DAC is consuming a minimal amount of power. To switch the unit on, press the **Power button (4)** on the front of the unit or the remote control. The display will now light up and the **POWER LED** will light up. The LEDs illuminating the Nuvistor valves will light up **RED**. This means the outputs are muted, and will remain in this state for about 12 seconds, so no sound will be heard. Once the delay is up, these LEDs go **ORANGE**, indicating the unit is ready for use, and any source material selected and playing will be heard. For the first 15 mins or so, the Nu-Vista valves are still warming up, and their LEDs stay **ORANGE**. After approx. 20 mins the valves will have reached full thermal equilibrium and are at their best performance, which is indicated by their LEDs turning **BLUE**.

Input selection

The Nu-Vista DAC has a total of seven inputs available. These are Optical 1, 2, and 3, Coaxial, AES/EBU, USB and also I2S (I2S is reserved for a later to be release Nu-Vista CD player).

After a Factory Reset the USB input is selected and the volume is set to -42dB.

When the Nu-Vista DAC is taken out of sleep mode, it will default to the last input selected.

From the front panel you can cycle through the inputs by using the input selector wheel 1.

The remote control has direct access buttons for each input. Simply press the appropriate button to move directly to that input.

Optical, coaxial & AES/EBU inputs

These are capable of accepting up to 24 bit 192 kHz PCM stereo, MQA 384kHz, and DoP DSD 64 data streams. The incoming data sample rate is displayed on the front panel display for reference.

USB Input

The USB input is capable of accepting up to 24 bit 768 kHz PCM, DSD 256 (native DSD 512) data streams and all MQA data streams.

Computer settings for USB

A good quality USB 2.0 cable is required to connect the unit to the computer. Normal USB standards stipulate that this should be 5M or less; and we recommend keeping it as short as possible.

WARNING: Older USB cables are often heavy and bulky and must be supported to avoid damage to the USB socket. Any physical damage caused to this socket will not be covered by warranty.

The computer should now detect the Nu-Vista DAC. A driver installation is only required on Windows.

- Linux kernel 2.6.33 or later (no driver required)
- Apple OS X® 10.6.4 or later (no driver required)
- Windows 10 Creators Edition or later (driver found on included CD or on Musical Fidelity website)

For playing native DSD on Windows a driver installation is required.

Any device that is compliant to the USB Audio Class 2.0 standard should also operate with the Nu-Vista DAC. However Musical Fidelity are unable to provide support for operation with anything other than the system listed above.

CD, MP3, WAV, AAC/+, OGG, FLAC, and any other audio file types played on suitable playback software will now play through the unit.

Note: This USB input has a high-speed serial data processor, and by its nature, requires a very high volume of USB bandwidth. It will benefit greatly from being the only device connected on its USB 'bus'. Sharing the same bus with other devices could cause unwanted artifacts such as dropouts or temporary loss of signal. This especially includes the use of the unit on a USB hub/splitter whether alongside other USB components or not. A direct connection to the host computer by shortest USB 2.0 lead possible is very much recommended.

NU - VISTA DAC

Menu Navigation

Enter the menu by pressing Enter **6** or the up/down/right arrow button on the remote. Use the Back **5** and Enter **6** buttons to enter sub-menus or go a step back. On the remote this is done with the left and right arrow buttons. Confirm your setting with the Enter **6** button or the OK button on the remote. After 10 seconds of inactivity, the screen switches back to the main view.

Main View

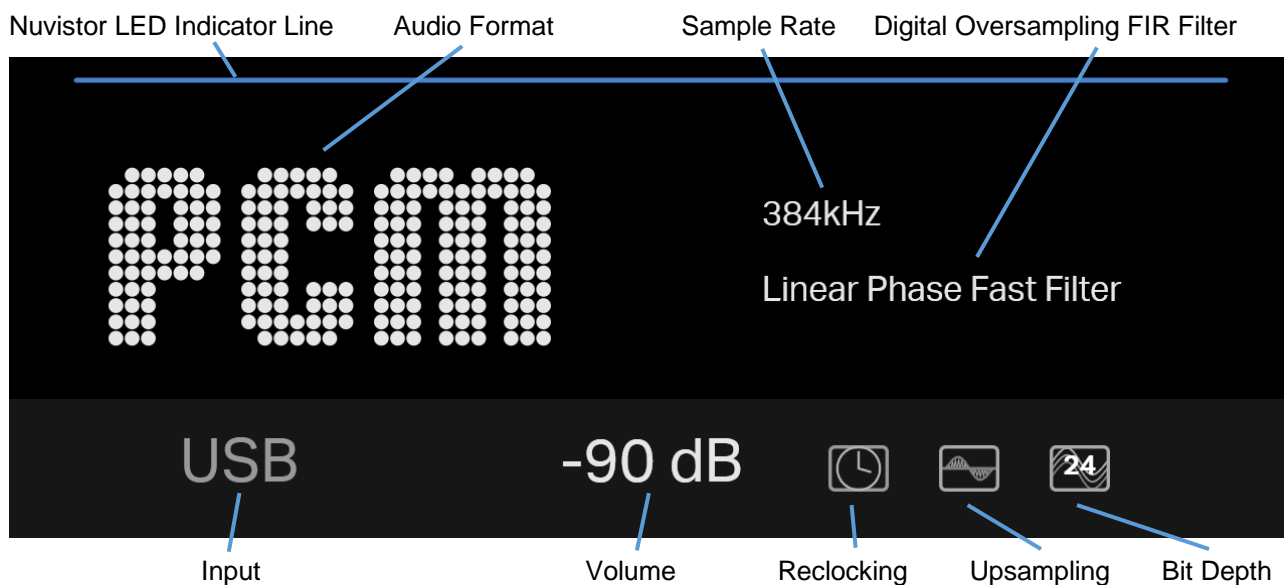

Nuvistor LED Indicator Line

Indicates that device Nuvistor tube LED's are on. The blue LED's can be turned on and off by holding the Back **5** button for 2 seconds. If the blue LED's are turned off, the blue top line is not displayed either.

Audio Format

- DSD - Direct Stream Digital - Native 64/128/256/512 or DSD over PCM - DoP 64/128/256
- PCM - Pulse-code Modulation - 44,1k/48k/88,2k/96k/176,4k/192k/352,8k/384k/702,6k/768kHz
- OFS - Original Frequency Spectrum (with magenta dot) - 44,1k/48k/88,2k/96k/176,4k/192k/352,8k/384kHz
- MQA Studio (with blue dot) - 44,1k/48k/88,2k/96k/176,4k/192k/352,8k/384kHz
- MQA (with green dot) - 44,1k/48k/88,2k/96k/176,4k/192k/352,8k/384kHz

MQA (Master Quality Authenticated)

The Nu-Vista DAC includes MQA technology which enables you to play MQA audio files and deliver the sound of the original master recording. Visit mqa.co.uk for more information.

MQA Indicators:

MQA - Green dot - indicates that the product is decoding and playing an MQA stream or file, and denotes provenance to ensure that the sound is identical to that of the source material.

MQA Studio - Blue dot - indicates it is playing an MQA Studio file, which has either been approved in the studio by the artist/producer or has been verified by the copyright owner.

OFS - Magenta dot - (Original Frequency Spectrum) confirms that the product is receiving an MQA stream or file which is already decoded. This delivers the final unfold of the MQA file delivered by services like TIDAL or media players like Roon.

NU - VISTA DAC

Sample Rate

Displays the sample rate of the incoming audio signal.

Digital Oversampling FIR Filter

Displays the currently set digital oversampling FIR filter. Choose your digital filter in the **Audio Settings -> Digital Filters** sub-menu or by pressing the **FILTER UP** and **FILTER DOWN** buttons on the remote. For a detailed description of each filter see page 14.

Note: When playing MQA files, the user's filter setting is not active, the MQA filter is always used. The MQA filter is a proprietary custom-made filter by MQA for our DAC to ensure the best possible MQA experience.

DSD filter: During DSD playback, the DAC's internal DSD filter is turned on and the digital filters have no effect.

Oversampling bypass: for sample rates of 705,6k and 768kHz the oversampling FIR filters cannot be set and are automatically bypassed. The unit goes into oversampling bypass mode. At these high sample rates (native sample rates of the DAC) the digital signal goes directly into the DAC without filtering. Effectively, this turns off all remaining filtering, improving audio parameters and the frequency spectrum by yet another step. In this mode the internal oversampling filter block of the ESS DAC chip can be bypassed and powered down, reducing the on-chip PSU / ground noise and consequently reducing signal correlated clock modulation on the ESS DAC's silicon die. The oversampling filter is the largest single digital section "block" on the DAC by silicon area.

Upsampling is automatically disabled for 705,6k and 768kHz sample rates.

Input

Displays the currently used input.

Volume

Displays the current volume level. Volume can be set with the Volume wheel **3** or the **VOL DOWN** and **VOL UP** buttons on the remote. Levels from -90dB to 0dB in 1dB volume steps are possible. The MUTE button on the remote mutes and unmutes the unit. If mute is active, a corresponding icon  is shown in place of the volume display.

The outputs can be set to fixed output (no volume control) by disabling the volume control in the menu screens under **Audio Settings -> Volume Control**. Fixed mode (Volume Control **DISABLED**) is suitable for connection to other equipment which offers a volume control. Variable mode (Volume Control **ENABLED**) allows connection directly to power amplifiers or active speakers where the Nu-Vista DAC provides the volume control.

Reclocking

Reclocking synchronizes digital audio signals with the master clock in the Nu-Vista DAC. Reclocking can be turned on and off in the menu screens under **Audio Settings -> Reclocking** or by pressing the **RECLK** button on the remote. If reclocking is active, a corresponding icon  is shown.

Upsampling

For incoming PCM signals, upsampling can be turned on or off in the menu screens under **Audio Settings -> Upsampling** or by pressing the **UPSAMP** button on the remote. When turned on, incoming PCM data up to

NU - VISTA DAC

192kHz sample rate is resampled to the sampling frequency of 352,8kHz or 384kHz according to the original multiple of the sampling frequency. If upsampling is active, a corresponding icon  is shown.

Note: Upsampling is automatically turned off for 705,6k and 768kHz sample rates.

Bit Depth

Displays the bit depth of the incoming audio signal:

- 1 bit - only used for DSD
- 16 bit - used for PCM, MQA, OFS
- 24 bit - used for PCM, MQA, OFS

System settings

Theme: using the menu screens under **System Settings -> Theme** you can set the display to dark or light mode.

Brightness: using the menu screens under **System Settings -> Brightness** you can set the display brightness level. Setting the brightness to the lowest level turns the display off. When the unit is controlled, the display is briefly turned on and switches back off after 3 seconds of inactivity.

Factory Reset: using the menu screens under **System Settings -> Factory reset** you can perform a factory reset. This resets all settings (audio settings and system settings) to factory default values.

About: using the menu screens under **System Settings -> About** you can view legal and firmware information.

NU - VISTA DAC

Digital Filters

The Nu-Vista DAC allows for detailed tuning of the audio experience. It comes with multiple preset reconstruction filters built-in. Musical purists can simply unpack the Nu-Vista DAC, carefully cable it up, just leave it at its standard settings and feel the immediate musical integration: the whole sound is sweet and clear; the treble is completely grain free and extended. The bottom end sounds endless with tactile bass dynamics.

As you get reintroduced to your music library, you might, at some point, want to discover what else is possible and hear it from different stages. It is then, when the customizability and settings turn the Nu-Vista DAC into a powerful tool for experts, which elevates it into a league of its own. Explore the sound stage with upsampling and reclocking or without and see if you are drawn in deeper.

Choose between the different digital filters and tailor the sound reproduction to your specific liking or to your specific setup. In a way the Nu-Vista DAC can be used like a professional tool for the experienced user:

1. **Linear Phase Fast:** fast roll off - Most common filter with clean overall suppression and excellent rejection, best for music with large transients. Provides crisp clean highs.
2. **Linear Phase Slow:** slow roll off - Low group delay - and symmetrical input response. Less ringing than linear-phase fast roll-off. Punchier bass than LPFR, with clean highs.
3. **Minimum Phase Fast:** fast roll off - Minimal pre-ringing, preferred for imaging and soundstage. No aliasing in frequency domain. Stronger bass than linear-phase, clean highs.
4. **Minimum Phase Slow:** slow roll off - Non-symmetrical filter designed to minimize pre-ringing. Strong punchy bass with good transient attacks.
5. **Apodizing Fast Filter:** fast roll off – A version of the linear-phase fast roll off filter optimized to improve pre-ringing.
6. **Corrected Phase Fast:** fast roll off – A combination of linear-phase and minimum-phase. Fast transient attack, strong punchy bass, crisp highs.
7. **Brick Wall Filter:** One of the earliest designs, intended for highest suppression possible, with high delay and pre-ringing. Linear-phase, crisp clean highs.
8. **Optimal Transient:** Our proprietary custom filter. In this filter we trade off frequency domain performance for optimum time domain performance resulting in a slight frequency roll-off at 20kHz, but zero pre-ringing and zero post ringing.

Troubleshooting

Problem	Probable Cause	Remedy
No power.	Power plug is not inserted into socket correctly.	Plug in securely into unit's IEC socket.
Excessive hum from system speakers.	Audio connector plug not fully pushed in. Cable Fault. Unsuitable Cable (e.g. cable grounds not connected).	Insert plug securely. Check cable is connected at both ends. Some "esoteric" cables have internal wiring intentionally disconnected/modified. For best results on all inputs, please use good quality screened coax; signal and screen directly connected both ends.
Digital input not working.	No connection to that input. Incorrect input selected. Wrong data type sent to DAC.	Check connection and cable. Select correct input. Check source digital output is set for "16 bit stereo PCM" or similar. This particularly applies to some TVs, most DVD players, and other home theatre type devices that may give a multichannel digital output. Refer to the source's manual for further information.
No audio output, or too low level output.	Incorrect or missing connections. USB Driver not selected.	Check connections and make sure they are secure. See the Musical Fidelity website for relevant OS setup information.
Dropouts in sound.	Digital input lead not properly connected. Faulty digital input lead. Faulty optical lead.	Check input lead is fully secured. Change lead. Please use a good quality straight-through signal-and-ground phono to phono lead. Optical lead breakage. This can occur if the optical lead is bent into a radius too small. Avoid tight corners in routing optical leads.
No audio output from USB input.	USB Cable not connected. M6 USB Driver not selected.	Check connections and make sure they are secure. See software section for relevant OS setup information. Please check device is listed in device manager (Windows®) or in Sound, audio devices for MAC OS X. Make sure the Musical Fidelity USB audio device is selected as the default OUTPUT device. Check USB port functions with another device.
Not detected when connected to USB.	USB Cable faulty. USB not working/ enabled on computer. Correct USB drivers not installed.	Check and replace cable. Check USB port functions with another device. Download and install the device driver from the software downloads section on the Musical Fidelity website.
Dropouts in sound (USB input).	Shared USB port with another device. Computer busy with another application. Computer low on resources.	Avoid sharing the USB port with other devices, if possible. At times an application (program) may intervene, sometimes invisibly e.g. a virus scanner. When this happens, computer resources are temporarily used up, and playback may suffer. This is not a fault. Try running fewer applications if possible.

If none of these actions affect a cure, please contact the dealer, or an authorised Musical Fidelity service agent.

Remember; never open the case of the Nu-Vista DAC, as this will invalidate the warranty.

DAC

DAC circuit	32 bit Hyperstream II
DAC chip	2x ES9038Q2M (dual differential) with 8x digital filter
Total correlated jitter	<12 picoseconds peak to peak
Frequency response	-0,5dB at 10kHz and 20kHz
Channel separation	< -130dB at 10kHz @ 0dBFS
SNR	> 120dB „A“-wt. at 1kHz @ 0dBFS
THD	< 0,002% at 1kHz @ 0dBFS
THD+N	< 0,003% at 1kHz @ 0dBFS

Digital Inputs

USB input	USB Audio Class 2 requires USB 2.0 or higher on computer
USB PCM sample rates	up to 768kHz / 24 bit
USB DSD support	up to DSD256 via DoP and native DSD512
USB MQA support	full MQA decoding by hardware
Optical Toslink® input	3x up to 24bit / PCM 192kHz, MQA 384kHz, DoP DSD 64
Coaxial RCA input	1x up to 24bit / PCM 192kHz, MQA 384kHz, DoP DSD 64
AES/EBU balanced input	1x up to 24bit / PCM 192kHz, MQA 384kHz, DoP DSD 64

Analogue Outputs

Line level outputs	1 x line level single ended RCA connectors; 2V RMS at 0dBFS 1 x line level balanced XLR connectors; 4V RMS at 0dBFS
Output impedance	10 ohms

Power requirement

Mains voltages	115/230VAC 50/60Hz (factory pre-set) 100VAC 50/60Hz (alternative)
Consumption	<0.5W in standby mode (orange LED ON) 40W maximum

Weight

Unit only, unboxed	21,5 kg
In shipping box	29,5 kg

Maximum Dimensions

Nu-Vista DAC (WxHxD)	483 x 187,5 x 491 (506 with connectors) mm
----------------------	--

Standard accessories

1x IEC type mains lead	10-Amp type
Remote control	Nu-Vista DAC remote
Batteries	LR03 or AAA, manganese alkaline type 2 off
4x Spike Foot	
4x Spike Foot Cup	
4x Spike Foot Screw	
4x Felt pad for Spike Foot Cup	
4x Felt pad for Standard Foot	

Musical Fidelity reserves the right to make improvements which may result in specification or feature changes without notice.



RELEASE

DATE

CHANGES

Nu-Vista DAC

3rd October 2023

1st issue

DISPOSAL



The crossed out wheeled bin label that appears on the back panel of the product indicates that the product must not be disposed of as normal household waste. To prevent possible harm to the environment please separate the product from other waste to ensure that it can be recycled in an environmentally safe manner. Please contact local government office or retailer for available collection facilities.



DISPOSITION

La poubelle sur roulettes barrées X, qui apparaît en logo sur le panneau arrière du produit, indique que celui-ci ne doit pas être traité comme un déchet domestique commun. Afin de protéger l'environnement, ce produit électronique devra être géré séparément et donc recyclé selon les nouvelles normes Européennes Rohs concernant les déchets d'appareils électroniques. Prière de contacter les services concernés gouvernementaux ou votre point de vente pour l'élimination et l'enlèvement de déchets électroniques équipés de composants électroniques.



DISPOSAL

La etiqueta cruzada hacia fuera del compartimiento que aparece en el panel trasero del producto indica que el producto no se debe reciclar como basura normal de la casa. Para prevenir daños posible al ambiente separe por favor el producto de otra basura para asegurarse de que puede ser reciclada de una manera ambientalmente segura. Entre en contacto por favor a su oficina gubernamental local o a su minorista para las instalaciones disponibles de la colección.



RIFIUTI

L'etichetta del cassonetto barrato riportato sul retro dell'apparecchio indica che il prodotto non deve essere smaltito tramite la procedura normale di smaltimento dei rifiuti domestici. Per evitare eventuali danni all'ambiente, separare questo prodotto da altri rifiuti domestici in modo che possa venire riciclato in base alle procedure di rispetto ambientale. Per maggiori dettagli sulle aree di raccolta disponibili, contattate l'ufficio governativo locale od il rivenditore del prodotto.



FACHGERECHTE ENTSORGUNG:

Das auf der Geräterückseite angebrachte Label deutet darauf hin, dass das Produkt nicht mit konventionellem Hauskehricht entsorgt werden darf. Um Schäden und Verschmutzungen an Umwelt und Mensch zu vermeiden, muss das Produkt fachgerecht entsorgt und von anderem Abfall getrennt werden. Wenden Sie sich bei Fragen hierzu an Ihren Fachhändler oder an eine öffentliche Informationsstelle.



AFVAL

Het label op de achterzijde van dit apparaat, een afvalbak op wielen met een kruis doorgehaald, geeft aan dat dit apparaat niet samen met gewoon huishoudafval mag worden weggegooid. Om mogelijke schade aan onze leefomgeving te voorkomen dient dit apparaat, gescheiden van gewoon huishoudelijk afval, te worden afgevoerd zodat het op een milieuvriendelijke manier kan worden gerecycled. Neem voor beschikbare inzamelplaatsen contact op met uw gemeentelijke reinigingsdienst of met uw elektronica leverancier.



HÄVITTÄMINEN

Yliaruksattua jäteastiaa kuvaava tarra tuotteen takalevyssä kertoo, että tuotetta ei saa käsitellä normaalina talousjätteenä. Ympäristön suojelemiseksi on tuote pidettävä erillään muusta jätteestä ja se on kierrätettävä ekologisesti kestäväällä tavalla. Ota yhteyttä laitteen myyjään tai Pirkanmaan Ympäristökeskukseen lähimmän kierrätyskeskuksen löytämiseksi.



AFSKAFNING

Logoet med en skraldespand med kryds over på bagsiden af apparatet indikerer at dette produkt ikke må kasseres som normal husholdningsaffald. For at forebygge mulig skade på miljøet, bedes De separere dette produkt fra andet affald, og sikre at det bliver genbrugt på en miljørigtig måde. Kontakt venligst de lokale myndigheder eller din forhandler for oplysning om nærmeste tilgængelige opsamlingssted for elektronikaffald.



ΔΙΑΔΙΚΑΣΙΑ ΑΠΟΡΡΙΨΗΣ

ΤΟ ΣΗΜΑ ΜΕ ΤΟΝ ΔΙΑΓΕΓΡΑΜΜΕΝΟ ΤΡΟΧΗΛΑΤΟ ΚΑΔΟ ΑΠΟΡΡΙΜΑΤΩΝ ΣΤΗΝ ΠΙΣΩ ΟΨΗ ΤΟΥ ΜΗΧΑΝΗΜΑΤΟΣ

ΔΗΛΩΝΕΙ ΟΤΙ ΤΟ ΠΡΟΙΟΝ ΑΥΤΟ ΔΕΝ ΠΡΕΠΕΙ ΝΑ ΔΙΑΧΕΙΡΙΣΘΕΙ ΣΑΝ ΣΥΝΗΘΙΣΜΕΝΟ ΟΙΚΙΑΚΟ ΑΠΟΒΛΗΤΟ. ΠΡΟΣ ΑΠΟΦΥΓΗ ΕΝΔΕΧΟΜΕΝΗΣ ΕΠΙΒΑΡΥΝΣΗΣ ΤΟΥ ΠΕΡΙΒΑΛΛΟΝΤΟΣ, ΞΕΧΩΡΙΣΤΕ ΤΟ ΠΡΟΙΟΝ ΑΠΟ ΤΑ ΑΛΛΑ ΑΠΟΡΡΙΜΑΤΑ ΩΣΤΕ ΝΑ ΕΞΑΣΦΑΛΙΣΘΕΙ Η ΑΝΑΚΥΚΛΩΣΗ ΤΟΥ ΜΕ ΤΟΝ ΠΡΕΠΟΝΤΑ ΤΡΟΠΟ.

ΠΑΡΑΚΑΛΟΥΜΕ ΝΑ ΕΠΙΚΟΙΝΩΝΗΣΕΤΕ ΜΕ ΤΗΝ ΤΟΠΙΚΗ ΥΠΗΡΕΣΙΑ ΑΝΑΚΥΚΛΩΣΗΣ Η ΜΕ ΤΟ ΚΑΤΑΣΤΗΜΑ ΑΓΟΡΑΣ ΓΙΑ ΠΕΡΙΣΣΟΤΕΡΕΣ ΛΕΠΤΟΜΕΡΕΙΕΣ.

MUSICAL FIDELITY

Musical Fidelity

a Division of Audio Tuning
Vertriebs GmbH
Margaretenstraße 98,
A-1050, Vienna, Austria

www.musicalfidelity.com

Specifications and details
are correct as we go to
press, but in the interests of
product improvement they