



McIntosh Laboratory, Inc. 2 Chambers Street Binghamton, New York 13903-2699 Phone: 607-723-3512 www.mcintoshlabs.com

MP100
Phono Preampfier
Owner's Manual



The lightning flash with arrowhead, within an equilateral triangle, is intended to alert the user to the presence of uninsulated "dangerous voltage" within the product's enclosure that may be of sufficient magnitude to constitute a risk of electric shock to persons.

WARNING - TO REDUCE RISK OF FIRE OR ELECTRICAL SHOCK, DO NOT EXPOSE THIS EQUIPMENT TO RAIN OR MOISTURE.

IMPORTANT SAFETY INSTRUCTIONS!

PLEASE READ THEM BEFORE OPERATING THIS EQUIPMENT.

1. Read these instructions.
2. Keep these instructions.
3. Heed all warnings.
4. Follow all instructions.
5. Do not use this apparatus near water.
6. Clean only with a dry cloth.
7. Do not block any ventilation openings. Install in accordance with the manufacturer's instructions.
8. Do not install near any heat sources such as radiators, heat registers, stoves, or other apparatus (including amplifiers) that produce heat.
9. Do not defeat the safety purpose of the polarized or grounding-type plug. A polarized plug has two blades with one wider than the other. A grounding type plug has two blades and a third grounding prong. The wide blade or the third prong are provided for your safety. If the provided plug does not fit into your outlet, consult an electrician for replacement of the obsolete outlet.
10. Protect the power cord from being walked on or pinched particularly at plugs, convenience receptacles, and the point where they exit from the apparatus.
11. Only use attachments/accessories specified by the manufacturer.
12. Use only with the cart, stand, tripod, bracket, or table specified by the manufacturer, or sold with the apparatus. When a cart is used,



ATTENTION:
RISQUE DE CHOC ELECTRIQUE - NE PAS OUVRIR
NO USER-SERVICEABLE PARTS INSIDE. REFER SERVICING TO QUALIFIED PERSONNEL.

- use caution when moving the cart/apparatus combination to avoid injury from tip-over.
13. Unplug this apparatus during lightning storms or when unused for long periods of time.
 14. Refer all servicing to qualified service personnel. Servicing is required when the apparatus has been damaged in any way, such as power-supply cord or plug is damaged, liquid has been spilled or objects have fallen into the apparatus, the apparatus has been exposed to rain or moisture, does not operate normally, or has been dropped.
 15. Do not expose this equipment to dripping or splashing and ensure that no objects filled with liquids, such as vases, are placed on the equipment.
Ne pas exposer cet appareil à des éclaboussures ou gouttelettes d'un liquide. Aucun objet remplie de liquide comme par exemple un vase ne doit être placé sur l'appareil.
 16. If this equipment is supplied with a power supply cord only, the mains plug of the power supply cord shall remain readily operable. To completely disconnect this equipment from the a.c. mains remove the plug from the a.c. receptacle.
Si l'équipement est uniquement alimenté par un cordon d'alimentation, la fiche du cordon d'alimentation doit demeurer aisément accessible. Pour déconnecter complètement l'équipement du réseau d'alimentation, déconnecter la fiche du cordon d'alimentation de la prise murale.

The exclamation point within an equilateral triangle is intended to alert the user to the presence of important operating and maintenance (servicing) instructions in the literature accompanying the appliance.

To prevent the risk of electric shock, do not remove cover or back. No user-serviceable parts inside.

17. If this equipment is supplied with AC /DC Adapter with separate power supply cord or the AC/DC Adapter plugging directly into an a.c. receptacle, they shall remain readily operable. To completely disconnect this equipment from the a.c. mains remove the AC /DC Adapter mains power supply cord from the a.c. receptacle or remove the AC /DC Adapter when it is directly plugged into the a.c. receptacle.
Si l'équipement est alimenté par un adaptateur AC/DC munis d'un cordon d'alimentation ou un adaptateur AC/DC qui est alimenté directement à la prise murale, ils doivent demeurer aisément accessibles. Pour déconnecter complètement l'équipement du réseau d'alimentation, déconnecter l'adaptateur AC/DC de la prise murale ou déconnecter le cordon d'alimentation de l'adaptateur AC/DC de la prise murale.
18. **WARNING:** Do not expose batteries or battery pack to excessive heat such as sunshine, fire or the like.
AVERTISSEMENT: Les batteries ou bloc de batteries ne doivent pas être exposées à une chaleur excessive telle que celle du soleil, feu ou autre source de chaleur similaire.
19. **CAUTION:** danger of explosion if battery is incorrectly replaced. Replace only with the same or equivalent type.
ATTENTION: danger d'explosion si la pile n'est pas remplacée correctement. Ne remplacer que par le même type ou un type équivalent.
20. Connect mains power supply cord only to a mains socket outlet with a protective earthing connection.

Thank You

Your decision to own this McIntosh MP100 Phono Preamplifier ranks you at the very top among discriminating music listeners. You now have “The Best.” The McIntosh dedication to “Quality,” is assurance that you will receive many years of musical enjoyment from this unit.

Please take a short time to read the information in this manual. We want you to be as familiar as possible with all the features and functions of your new McIntosh.

Please Take A Moment

The serial number, purchase date and McIntosh Dealer name are important to you for possible insurance claim or future service. The spaces below have been provided for you to record that information:

Serial Number: _____

Purchase Date: _____

Dealer Name: _____

Technical Assistance

If at any time you have questions about your McIntosh product, contact your McIntosh Dealer who is familiar with your McIntosh equipment and any other brands that may be part of your system. If you or your Dealer wish additional help concerning a suspected problem, you can receive technical assistance for all McIntosh products at:

McIntosh Laboratory, Inc.
2 Chambers Street
Binghamton, New York 13903
Phone: 607-723-3512
Fax: 607-724-0549

Customer Service

If it is determined that your McIntosh product is in need of repair, you can return it to your Dealer. You can also return it to the McIntosh Laboratory Service Department. For assistance on factory repair return procedure, contact the McIntosh Service Department at:

McIntosh Laboratory, Inc.
2 Chambers Street
Binghamton, New York 13903
Phone: 607-723-3515
Fax: 607-723-1917

Table of Contents

Safety Instructions	2
Thank You and Please Take a Moment.....	3
Technical Assistance and Customer Service	3
Table of Contents	3
General Information	4
Connector and Cable Information	4
Introduction.....	5
Performance Features	5
Dimensions	6
Installation	7

Connections:

Rear Panel Connections	8
Connecting Components.....	10-11

Front Panel:

Front Panel Displays, Controls, Push-buttons	12
--	----

Operation:

How to Operate the MP100	13-16
--------------------------------	-------

Additional Information:

Photos.....	17
Specifications.....	18
Packing Instruction.....	19

General Information

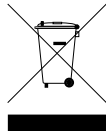
1. For additional connection information, refer to the owner's manual(s) for any component(s) connected to the MP100 Phono Preamplifier.
2. The Main AC Power going to the MP100 and any other McIntosh Component(s) should not be applied until all the system components are connected together. Failure to do so could result in malfunctioning of some or all of the system's normal operations. When the MP100 and other McIntosh Components are in their Standby Power Off Mode, the Microprocessor's Circuitry inside each component is active and communication is occurring between them.
3. The Balanced and Unbalanced Outputs may be used simultaneously, connected to different Preamplifiers or component recording device.
4. The MP100 internal Analog to Digital Converter Circuitry is designed to encode 2-channel PCM (Pulse Code Modulation) Digital Signal. The Coaxial and Optical Digital Audio Outputs are for PCM Digital Signals.
5. Sound Intensity is measured in units called Decibels and "dB" is the abbreviation.
6. When discarding the unit, comply with local rules or regulations. Batteries should never be thrown away or incinerated but disposed of in accordance with the local regulations concerning battery disposal. 
7. For additional information on the MP100 and other McIntosh Products please visit the McIntosh Web Site at www.mcintoshlabs.com.

Connector and Cable Information

XLR Connectors

Below is the Pin configuration for the XLR Balanced Output Connector on the MP100. Refer to the diagram for connections:

- PIN 1: Shield/Ground
- PIN 2: + Output
- PIN 3: - Output

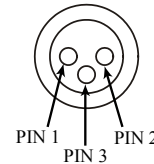

Power Control (Trigger) Connectors

When the MP100 TRIGger IN Connector receives a Power Control On Signal (5 to 12 volts) it will make that signal available at the TRIGger OUT Connector to control other connected McIntosh Components. An additional connection is for controlling the illumination of the Power Output Meters on McIntosh Power Amplifiers. A 3.5mm stereo mini phone plug is used for connection to the Power Control (Trigger) Connectors on the MP100.

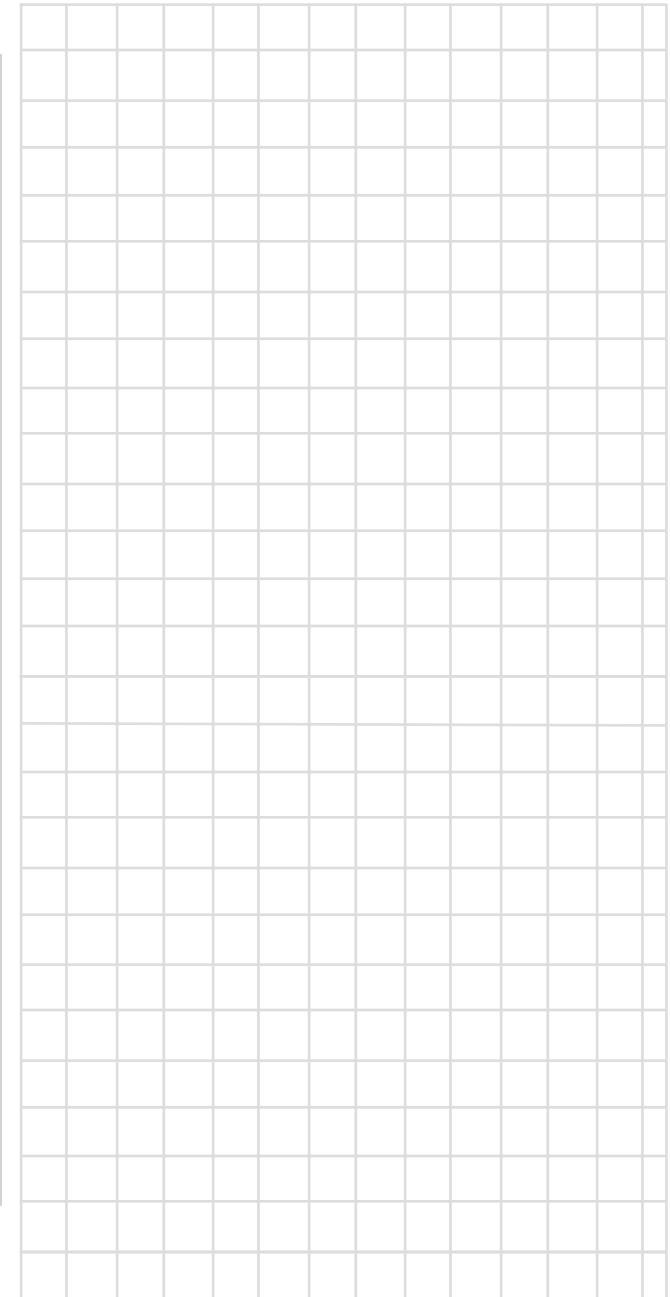
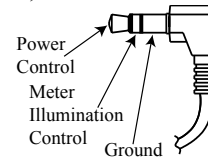

Introduction

The McIntosh Phono Preamplifier is one of the finest Phono Preamplifiers ever created and has the ability for connections to components with analog and digital inputs. The MP100 reproduction is sonically transparent and absolutely accurate. The McIntosh Sound is “The Sound of the Music Itself.”

Performance Features

• Electromagnetic Input Switching

Digital Logic Circuits drive Electromagnetic Switches on Inputs and operating functions for reliable, noiseless, distortion free switching.

• Moving Coil and Moving Magnet Phono Inputs

The MP100 has two precision Phono Preamplifier Circuits, one for Moving Coil Phono Cartridges and the other for Moving Magnet Cartridges. Both phono inputs have selectable loading. The circuits use the latest designs providing the lowest possible noise and distortion. The close tolerance resistors and capacitors used in the RIAA Correction Equalization Circuitry provides an extremely flat frequency response.

• Digital Audio Outputs

The Digital Outputs encode PCM Signals from the selected Phono Input. Coaxial and Optical Outputs process Digital Signals at 96kHz with 24-Bit resolution. The Digital Outputs have two different output levels settings and the Digital Circuitry can be switched Off providing a true analog only signal processing.

• USB Digital Audio Output

The USB Digital Output provides Digital Signals at 96kHz with 24-Bit resolution from the selected Phono Input.

• Balanced and Unbalanced Outputs

The Balanced Outputs allow the connection using long cable lengths without a loss in sound quality. The MP100 also has unbalanced Output connections for compatibility with a wide range of audio components.

• Power Control Connections

The Power Control (PWR CTRL) TRIGGER INPUT Connection provides convenient Turn-On/Off of the MP100 when connected to a McIntosh Component with Power Control TRIGGER OUT. The MP100 TRIGGER OUT Connection provides Turn-On/Off operation when connected with other McIntosh Audio Components.

• Special Power Supply

The Multi Regulated Power Supply ensures stable noise free operation even though the power line varies.

• LED Front Panel Illumination

The even Illumination of the Front Panel is accomplished by multiple extra long life Light Emitting Diodes (LEDs) arranged with a special orientation.

• Glass Front Panel and Super Mirror Chassis Finish

The famous McIntosh Illuminated Glass Front Panel and the Stainless Steel Chassis with Super Mirror Finish ensuring the pristine beauty of the MP100 will be retained for many years.

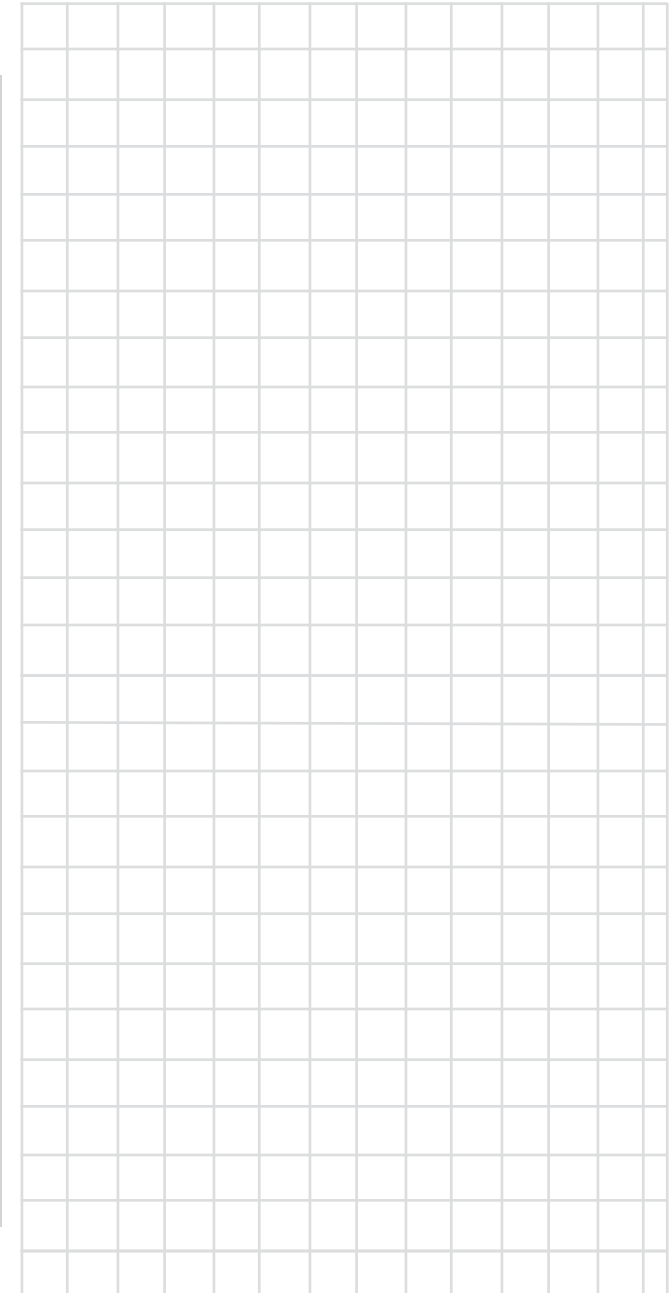

Dimensions

The following dimensions can assist in determining the best location for your MP100. There is additional information on the next page pertaining to installing the MP100 into cabinets.

Front View of the MP100

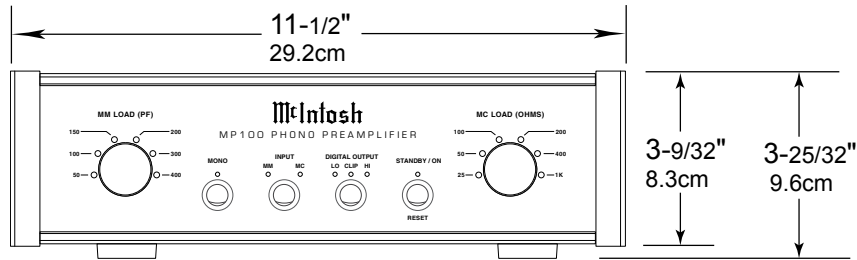

Side View of the MP100

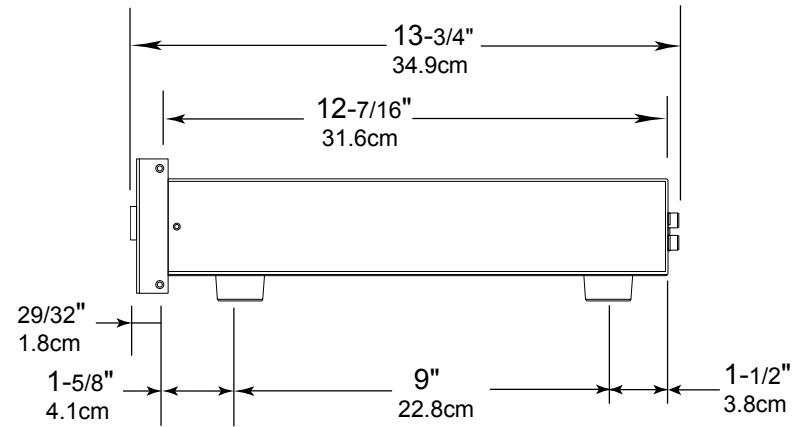

Rear View of the MP100

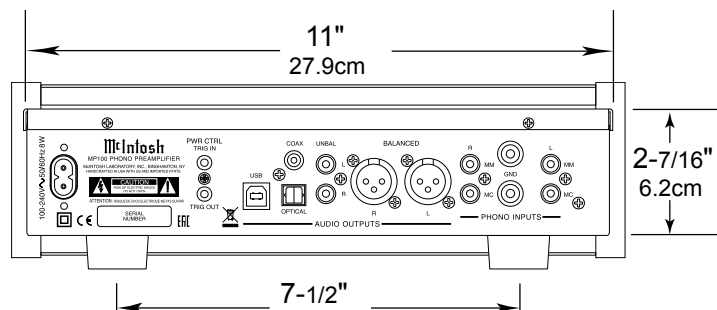

Installation

The MP100 Phono Preamplifier is designed to be placed upright on a table or shelf, standing on its feet. The required ventilation requirements are shown. Always provide adequate ventilation for your MP100. Cool operation ensures the longest possible operating life for any electronic instrument. Do not install the MP100 directly above a heat generating device, such as a Power Amplifier. Allow at least 1 inch (2.5cm) above the top, 7/8 inch (2.2cm) below the bottom and 1 inch (2.5cm) on each side of the MP100, so that airflow is not obstructed. Allow 16-3/4 inches (42.5cm) of depth for airflow and cable connections.

MP100 Front View

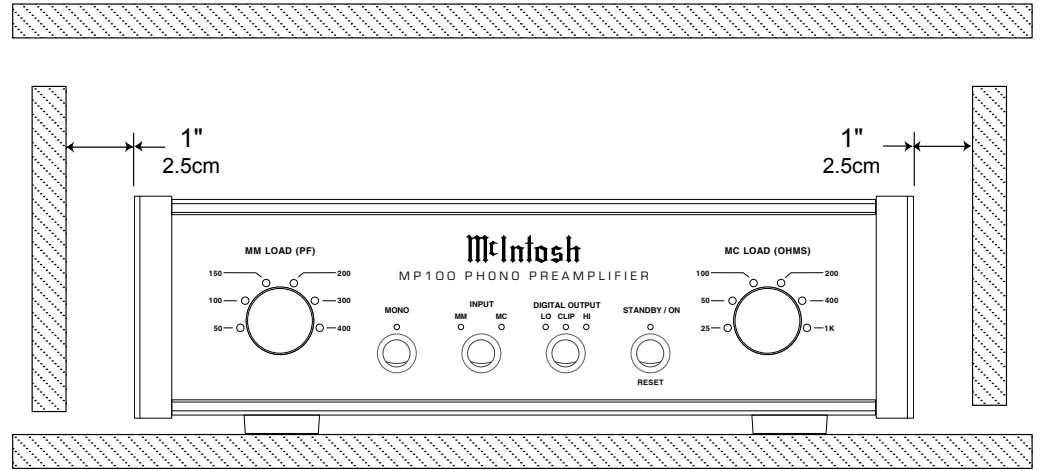

MP100 Side View

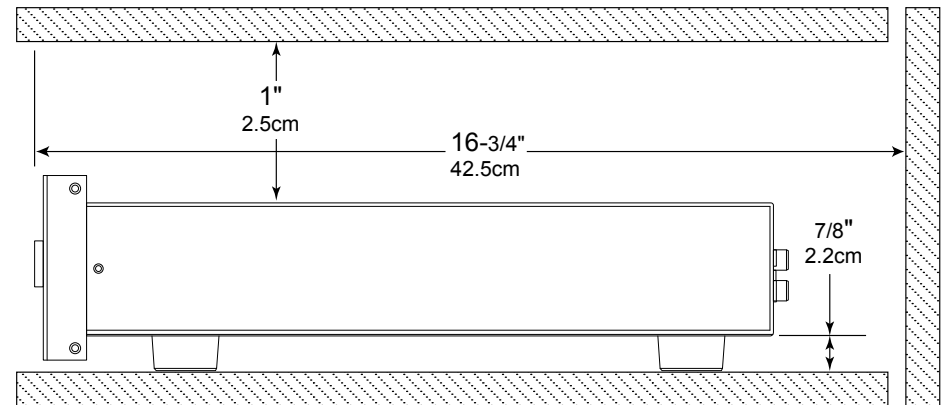



Rear Panel Connections

PWR CTRL (Power Control) TRIGger IN receives turn-on signals from a McIntosh component and TRIGger OUT sends turn-on signals on to another McIntosh Component

UNBALanced AUDIO OUTPUTS supply analog audio signals to Unbalanced Inputs of other components

COAXial Digital AUDIO OUTPUT sends a Digital Audio Signal to a Preampifier or an A/V Control Center with a D/A Converter or a Decoder

PHONO MM accepts signals from a Moving Magnet Phono Cartridge

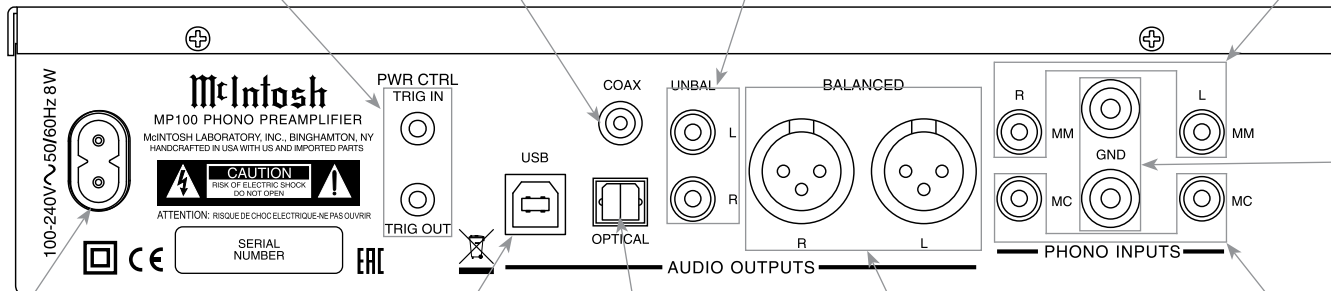

GND terminals accept a ground wire from a turntable

Connect the MP100 power cord to a live AC outlet. Refer to information on the back panel of your MP100 to determine the correct voltage for your unit

OPTICAL Digital AUDIO OUTPUT sends a Digital Audio Signal to a Preampifier or an A/V Control Center with a D/A Converter or a Decoder

PHONO MC accepts the low level signals from a Moving Coil Phono Cartridge

USB DIGITAL AUDIO OUTPUT with control signal for connection to a computer

BALANCED AUDIO OUTPUTS supply analog audio signals to connect to Balanced Inputs of other components





Connecting Components

The MP100 has the ability to automatically switch power On/Off from Components via the PWR CTRL (Power Control) TRIGger connections. The connection instructions below, together with the MP100 Input/Output/Control Connection Diagram on the next page is an example of a typical audio system. Your system may vary from this, however the actual components would be connected in a similar manner. For additional information refer to “Connector and Cable Information” on page 4.

Power Control (Trigger) Connections:

1. Connect a Control Cable from the Integrated Amplifier PWR CNTRL (Power Control) Out Jack to the Power Control In on the Turntable.
2. Connect a Control Cable from the Turntable Power Control Out Jack to the MP100 PWR CTRL (Power Control) TRIG (Trigger) IN Jack.
3. Connect any additional Components in a similar manner, as outlined in steps 1 and 2.

Audio Connections:

4. Connect XLR Audio Cables from the MP100 AUDIO OUTPUTS BALANCED Connectors (Left and Right) to the Integrated Amplifier Balanced Analog Audio Input Connectors (Left and Right).
Note: Optional, using Audio Cables connect the MP100 Unbalanced Outputs to the Unbalanced Inputs on the Integrated Amplifier.
5. Connect the Audio Cables coming from the Turntable to the MP100 MC PHONO INPUT Jacks.
Note: If the Turntable has a Moving Magnet Cartridge, connect the Audio Cables to the MP100 MM PHONO INPUT Jacks instead of the MC Input Jacks.
6. Connect any additional Components in a similar manner, as outlined in steps 4 and 5.

Optional USB Connection:

7. Connect a USB cable with (Type A to Type B) connectors from the MP100 USB DIGITAL AUDIO OUTPUT connector to an available USB connector on the computer.

Optional Digital Connection:

8. Connect a Digital Optical Cable from the MP100 OPTICAL AUDIO OUTPUT Connector to the Integrated Amplifier Digital Audio Input Optical Connector.

Ground Connections:

9. Connect the Ground Cable coming from the Turntable to the MP100 PHONO INPUT GND Binding Post.

AC Power Cord Connections:

10. Connect the MP100 to a live AC Outlet using the supplied Power Supply Cord.



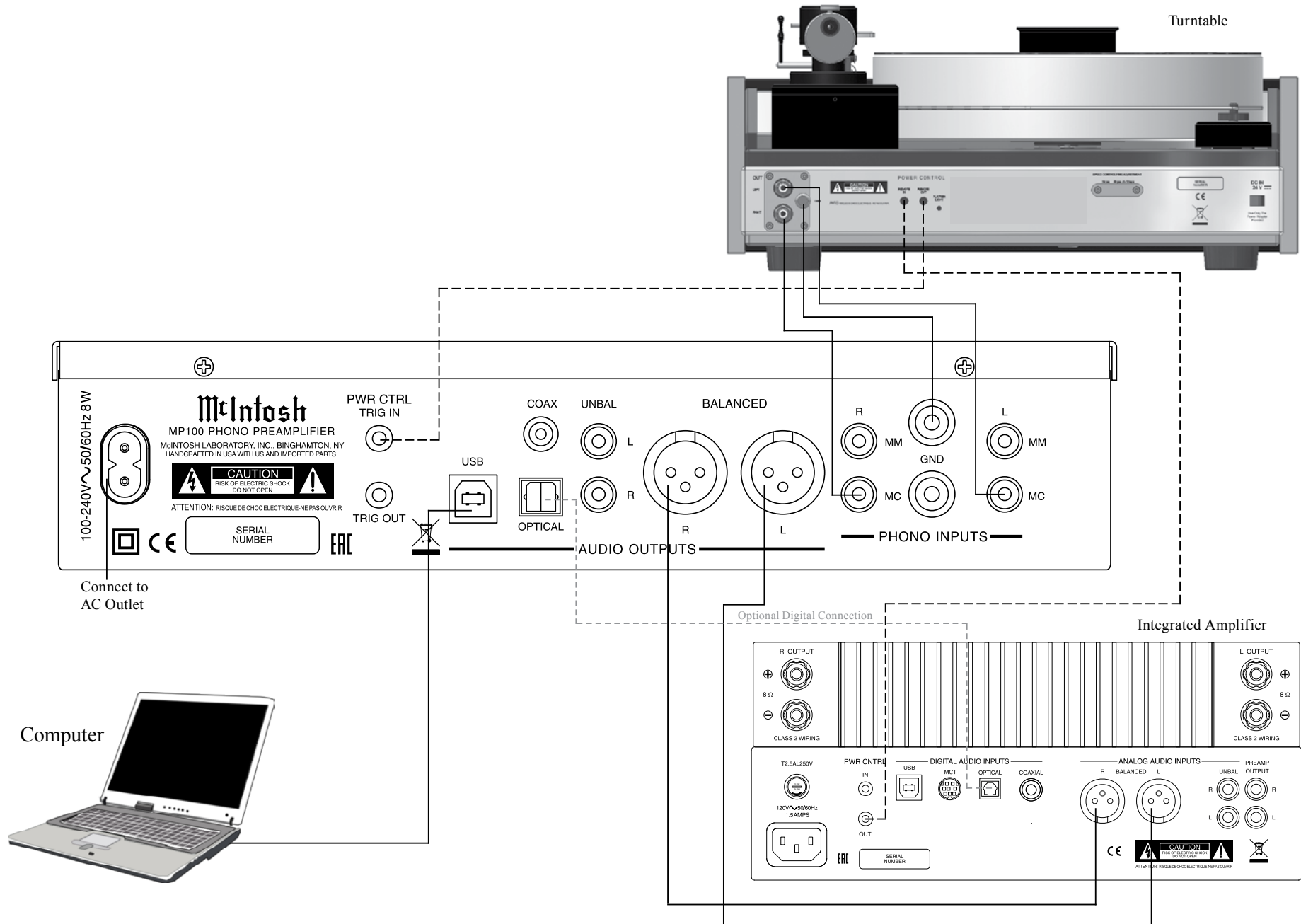

MM (Moving Magnet) LOAD (PF) Control with indicators, used to select the capacitive value in picofarads added to the Input Signal Path for a flat Frequency Response from the connected MM Phono Cartridge

MC (Moving Coil) LOAD (OHMS) Control with indicators, used to select the resistive value in ohms added to the Input Signal Path for a flat frequency response from the connected MC Phono Cartridge

INPUT Push-button with indicator, used to select the Turntable Phono Cartridge type either Moving Magnet (MM) or Moving Coil (MC)

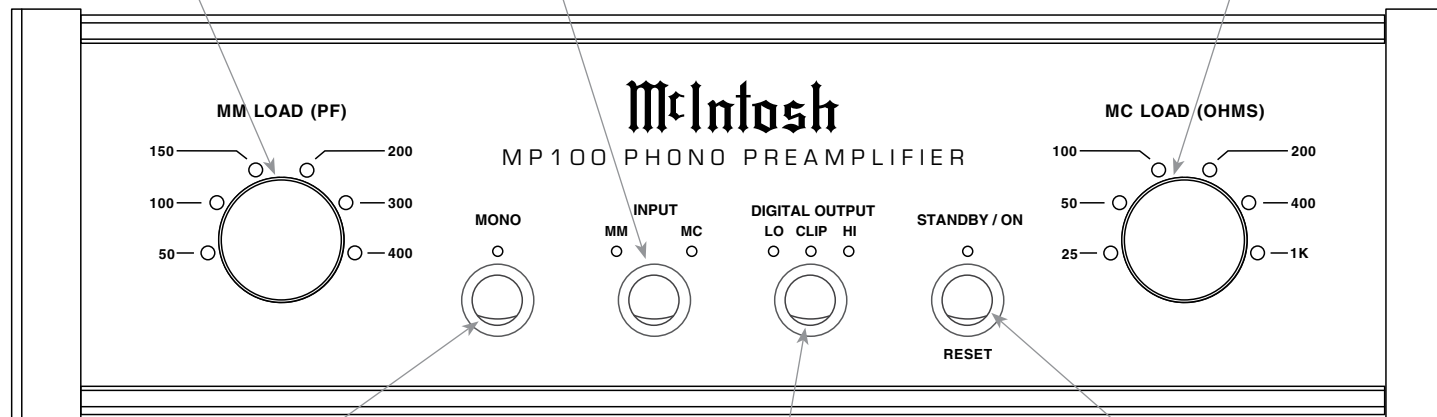

MONO Push-button with indicator, combines the Left and Right Channel signals for Monophonic Sound

STANDBY/ON Push-button with indicator, switches the MP100 ON or OFF (Standby) and resets the microprocessors

DIGITAL OUTPUT Push-button with indicators, provides either a LOw or HIgh Audio Level to the Analog-to-Digital Converter Circuitry. There is also a "CLIP" indicator showing when to select the LO DIGITAL OUTPUT mode

How to Operate the MP100

Power On and Off

The Red LED above the STANDBY/ON Push-button lights to indicate the MP100 is in Standby mode. To switch ON the MP100, press the STANDBY/ON Push-button on the Front Panel.

Note: When the MP100 PWR CTRL (Power Control) TRIGGER INput is connected to other components with a Power Control (Trigger) Out, the MP100 will automatically go On/Off. Refer to pages 10 and 11 for additional information.

Power Mode

The MP100 incorporates an Auto Off Feature, which automatically places the Phono Preamplifier into the Power Saving Standby/Off Mode. This occurs approximately 30 minutes after there has been an absence of user activity (includes changes to any of the Operation Functions such as Input selection, Digital Output selection, etc) or absence of an audio signal. If it is desirable to disable the Auto Off Feature perform the following steps:

1. Press and hold in the INPUT Push-button until the MP100 Front Panel Illumination extinguishes and the Digital Output LO LED is illuminated, then release the INPUT Push-button. The Auto Off Feature is now deactivated.

If it is desirable to reactivate the Auto Off Feature perform step one again and this time the Digital Output HI LED will be illuminated. The Auto Off Feature is now reactivated.

Input Selection

Press the INPUT Push-Button to select either the MM (Moving Magnet) or the MC (Moving Coil) Phono Cartridge Input.

Phono Cartridge Load Adjustment

In order for a Phono Cartridge (MM or MC) to deliver sound with the flattest possible frequency response, it is important for the Phono Cartridge to be connected to electronics with an Input Impedance (resistance and capacitance) the same as the Cartridge Load Specifications. The MP100 offers capacitance adjustments for MM (Moving Magnet Phono Cartridges) and resistance adjustments for MC (Moving Coil Phono Cartridges).

Note: Check the information supplied with the Phono Cartridge or with the Turntable (if it was supplied with the Phono Cartridge already installed) for the cartridge's impedance value. If necessary, contact your dealer or the manufacture of the phono cartridge.

MM LOAD (PF) ADJUSTMENT

When the connected Turntable has a Moving Magnet Cartridge installed, use the MM LOAD (PF) Control to select from the six available capacitance values that is the closest to the Phono Cartridge requirement.

MC LOAD (OHMS) ADJUSTMENT

When the connected Turntable has a Moving Coil Cartridge installed, use the MC LOAD (OHMS) Control to select from the six available resistance values that is the closest to the Phono Cartridge requirement.

Stereo/Mono Mode

The Stereo Mode by default is active for the MM and MC Input Sources. To change from the Stereo Mode to Mono Mode, perform the following steps:

Note: The Stereo/Mono Mode affects all the MP100 Outputs (Analog, Digital and USB).

1. Select the desired Phono Input MM or MC.
2. Press the MONO Push-Button on the Front Panel,

the LED above the MONO Push-Button will illuminate.

3. Return to the STEREO Mode by pressing the MONO Push-Button.

Digital Output

The MP100 provides the greatest possible Dynamic Range when converting the Analog Audio Signal from the playback of Phonograph Recordings to a Digital Audio Signal. There are two Digital Output Settings to accommodate a wide range of Dynamic Range. For most recordings the DIGITAL OUTPUT HI Setting will produce excellent results. If the CLIP LED Flashes On, switching to the DIGITAL OUTPUT LO Setting will produce better results. To switch Off the DIGITAL OUTPUT Signal Processing, press the DIGITAL OUTPUT Push-button until the three LEDs are no longer illuminated.

USB Output Operation and Driver Installation

The MP100 USB Output provides the capability to record music on your computer from the playback of Phonograph Recordings through the MP100 Phono Preamplifier, when the computer is connected to the rear panel USB connector.

Notes: 1. The MP100 USB Output is for direct connection to a computer USB single input only.

2. To playback music from an USB Drive, connect the USB Drive to another USB Port on the computer and select the USB Drive with the Media Playback Program.

The MP100 USB Output is compatible with PC Computers using Microsoft®, Windows 7 (SP1), Windows 8.1 and Windows 10. It is also compatible with Apple® Macintosh® Computers using OS-10.6.8 or later.

When using a PC Computer with Windows, a spe-



How to Operate the MP100, con't

cial McIntosh USB Audio Software Driver needs to be installed on the PC Computer. The driver needs to be installed before connecting the MP100 USB Output to the USB Port on the computer.

Notes: 1. If your computer already has a McIntosh Windows USB Audio Software Driver (for current McIntosh Preamplifiers or Integrated Amplifiers) installed, it is VERY IMPORTANT TO FIRST UNINSTALL THE DRIVER BEFORE PROCEEDING. The new driver to be installed in the following steps offers additional capabilities for the MP100 and is compatible with current McIntosh Preamplifiers or Integrated Amplifiers

2. If an Apple Macintosh computer is used with the MP100, no additional driver is required.

The McIntosh USB Audio Windows Driver is available for download from the McIntosh Web Site: <http://www.mcintoshlabs.com/us/Support/Pages/Manuals.aspx>

Under “PRODUCT CATEGORY” select “Preamplifiers” then under “MODEL NUMBER” select “MP100”. Click on “SEARCH” then select “McIntosh-HD USB Audio Windows Drive D v2.0” and download the PC Windows Driver. Follow the instructions below to install the McIntosh MP100 Driver:

Purpose: To Install the McIntosh USB Audio Windows Driver for use with McIntosh Products with an USB-Digital Audio Input.

- Requirements:**
1. A PC Computer with a functioning USB Port.
 2. Windows 7 (SP1 or greater), Windows 8 (8.1) or Windows 10 Operating System.
 3. An USB Cable with Type A to Type B Connectors.

Installing the Software

It is important to first install the downloaded software on your computer before connecting the McIntosh Product to the computer. The USB Driver is included in the downloaded software package.

Note: Before installing this software, please check to see if the McIntosh Product(s) with the USB-Digital Audio Input has the latest firmware version, if not update the firmware first.

1. Unzip the downloaded McIntosh Windows USB Driver Software Package.
2. Run “McIntoshHDSwPkg_20160415_vlp9p110p3.zip”. Refer to figures 1 thru 4.



Figure 1

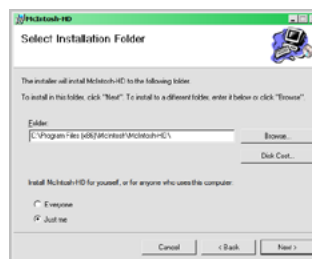

Figure 2

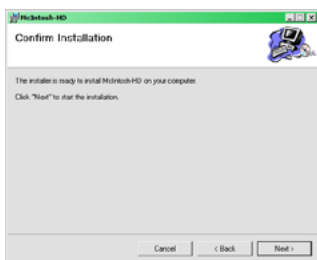

Figure 3

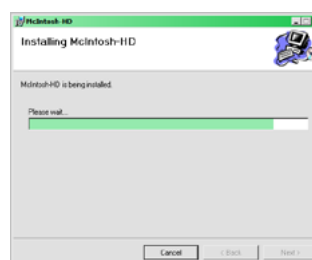

Figure 4

3. When the software has been installed, it is necessary to re-boot the computer. Refer to figures 5 and 6.

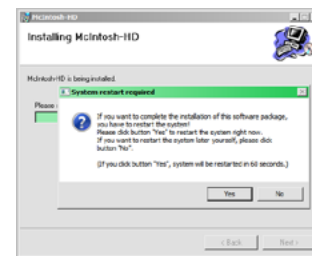

Figure 5

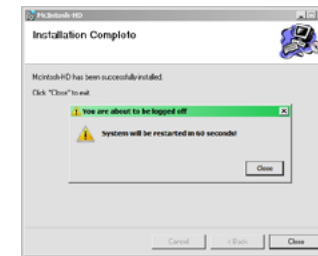

Figure 6

After rebooting, a McIntosh-HD icon will appear on the desktop. Refer to figure 7.

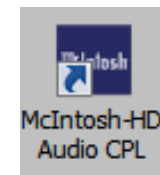

Figure 7

USB Connection

Connect the USB Cable with Type A to Type B connectors between the PC Computer and the McIntosh Product with the USB-Digital Audio Output. An Icon will appear On-Screen indicating Windows has found new hardware. Refer to figure 8.

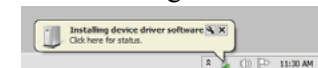

Figure 8

Upon completion of installing the driver, figure 9 will appear.

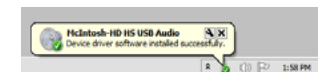

Figure 9

Windows Sound Settings

For proper operation of the McIntosh Product via the Computer USB Connection, it is required to make changes to Windows Sound Settings:

1. From the Windows START button, click on “CONTROL PANEL” followed by selecting “SOUND”. Refer to figure 10.

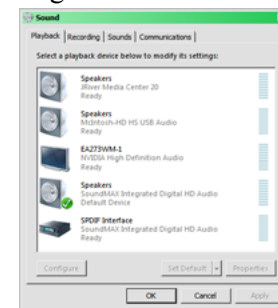

Figure 10

- Referring to figure 11, first select “McIntosh-HD HS USB Audio” and then click on the “Set Default” button.

Notes: 1. When the McIntosh USB Audio Product is not connected to your computer, the previous default Audio Device will be selected.

- If other McIntosh Products with USB Audio Connections are also connected to the computer, an additional “McIntosh USB Audio” playback device will appear in the listing. Make sure to select the “McIntosh-HD HS USB Audio” from available playback devices listed when using this McIntosh Product for USB Audio.

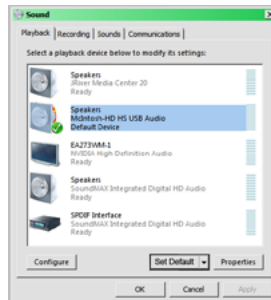

Figure 11

- The McIntosh-HD USB Audio Control Panel displays the current Sampling Rate, Bit-Rate and Buffer Size for the music streaming from the computer into the MP100.
- When the Media Stream Program on the computer is set to output in the “ASIO” format, the McIntosh -HD USB Audio Control Panel allows for changing the settings parameters on the fly.

Control Panel Settings

To activate the McIntosh-HD USB Audio Control Panel, Click on the “McIntosh Icon” (located in the Windows notification area on the right side of the task bar) or click on the Windows “Show hidden icons”, then select the “Mc-Intosh Icon”. Refer to figures 12 and 13.

Notes: 1. It is not necessary for the McIntosh-HD USB Audio Control Panel to be running, unless it is desired to make changes to the default settings.

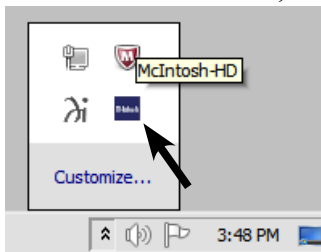

Figure 12



Figure 13

Making a Digital Recording

The MP100 Digital Outputs (Coaxial, Optical and USB) has a setting of 96,000Hz 24Bit resolution. Before proceeding it is important to change the McIntosh Audio Control Panel default resolution settings of 44,100Hz 16Bit to match MP100 setting of 96,000Hz 24Bit. Refer to figures 13 and 14.

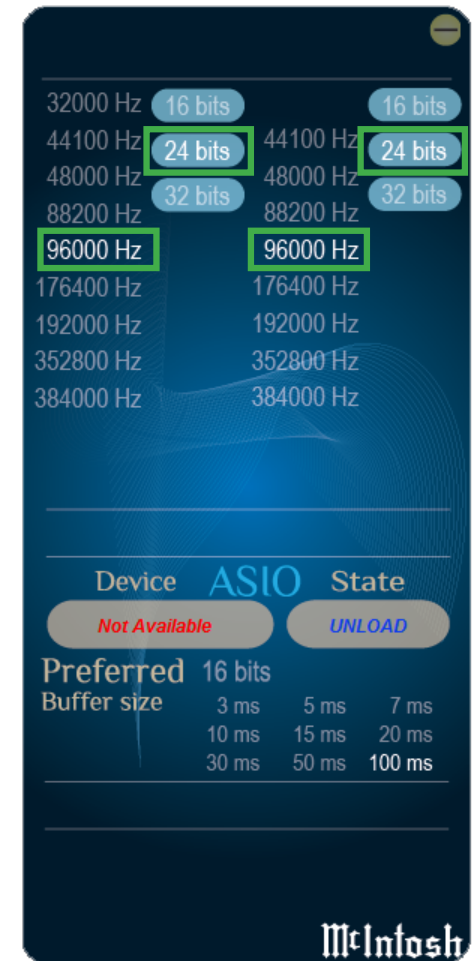

Figure 14



How to Operate the MP100, con't

Digital CD Audio Recorders can be connected to the MP100 Digital Audio COAXial or OPTICAL Output to make a Digital Copy of a Phonograph Recording. The most versatile way of making a digital recording is by using the USB Connection between the MP100 and a computer using a Digital Recorder Application. There are many third party Applications available for creating Digital Audio Albums. An example of just one of the available applications is "VinylStudio" by Alpinesoft.

Reset of Microprocessors

In the unlikely event the controls of the MP100 stop functioning, the microprocessors can be reset by performing the following:

1. Press and hold in the STANDBY/ON Push-button until all the Front Panel LEDs start flashing, then release the STANDBY/ON Push-button.
2. To switch the MP100 back On, press the STANDBY/ON Push-button.







Specifications

Frequency Response

±0.3dB from 20Hz to 20,000Hz

Total Harmonic Distortion

0.005% maximum from 20Hz to 20,000Hz

Rated Output

2V Balanced

1V Unbalanced

Maximum Voltage Output

16V RMS Balanced

8V RMS Unbalanced

Sensitivity (for rated output)

MM - 10mV

MC - 1mV

Signal To Noise Ratio (CEA490)

MM - 80dB

MC - 78dB

Input Impedance

MM - 50, 100, 150, 200, 300, 400pF; 47K ohms

MC - 25, 50, 100, 200, 400 or 1,000 ohms; 470pF

Maximum Input Signal

MM - 80mV

MC - 8mV

Voltage Gain

MM - 40dB

MC - 60dB

Output Impedance

200 ohms Balanced

100 ohms Unbalanced

Digital Output Sample Rates

Optical: PCM - 24Bit - 96kHz

Coaxial: PCM - 24Bit - 96kHz

USB: PCM - 24Bit - 96kHz

Power Control (Trigger)

Maximum Input and Output Signal 12VDC, 25mA

Power Requirements

100-240 Volts, 50/60Hz at 8 watts

Standby Power, less than 0.5 watts

Overall Dimensions

Width is 11-1/2 inches (29.2cm)

Height is 3-25/32 inches (9.6cm) including feet

Depth is 16-3/4 inches (42.5cm) including the Front Panel, Knobs and Cables

Weight

8.6 pounds (3.9 kg) net, 9.6 pounds (4.4 kg) in shipping carton

Shipping Carton Dimensions

Width is 16 inches (40.6cm)

Height is 9 inches (22.8cm)

Depth is 17 inches (43.1cm)

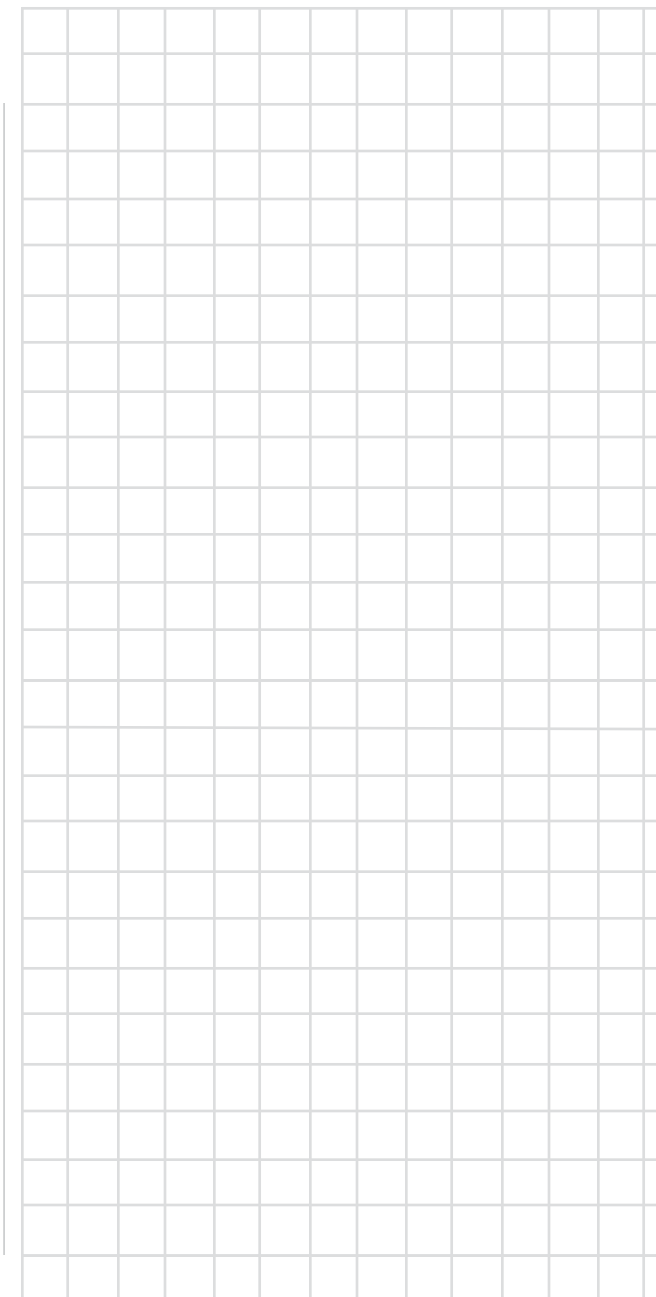

Packing Instructions

In the event it is necessary to repack the equipment for shipment, the equipment must be packed exactly as shown below. It is very important that the four plastic feet are attached to the bottom of the equipment. This will ensure the proper equipment location on the bottom pad. Failure to do this will result in shipping damage.

Use the original shipping carton and interior parts only if they are all in good serviceable condition. If a shipping carton or any of the interior part(s) are needed, please call or write Customer Service Department of McIntosh Laboratory. Refer to page 4. Please see the Part List for the correct part numbers.

Quantity	Part Number	Description
1	034565	Shipping carton only
2	034566	Side Foam Pad
4	163185	Plastic foot
4	400159	#10-32 x 3/4" screw
4	404080	#10 Flat washer

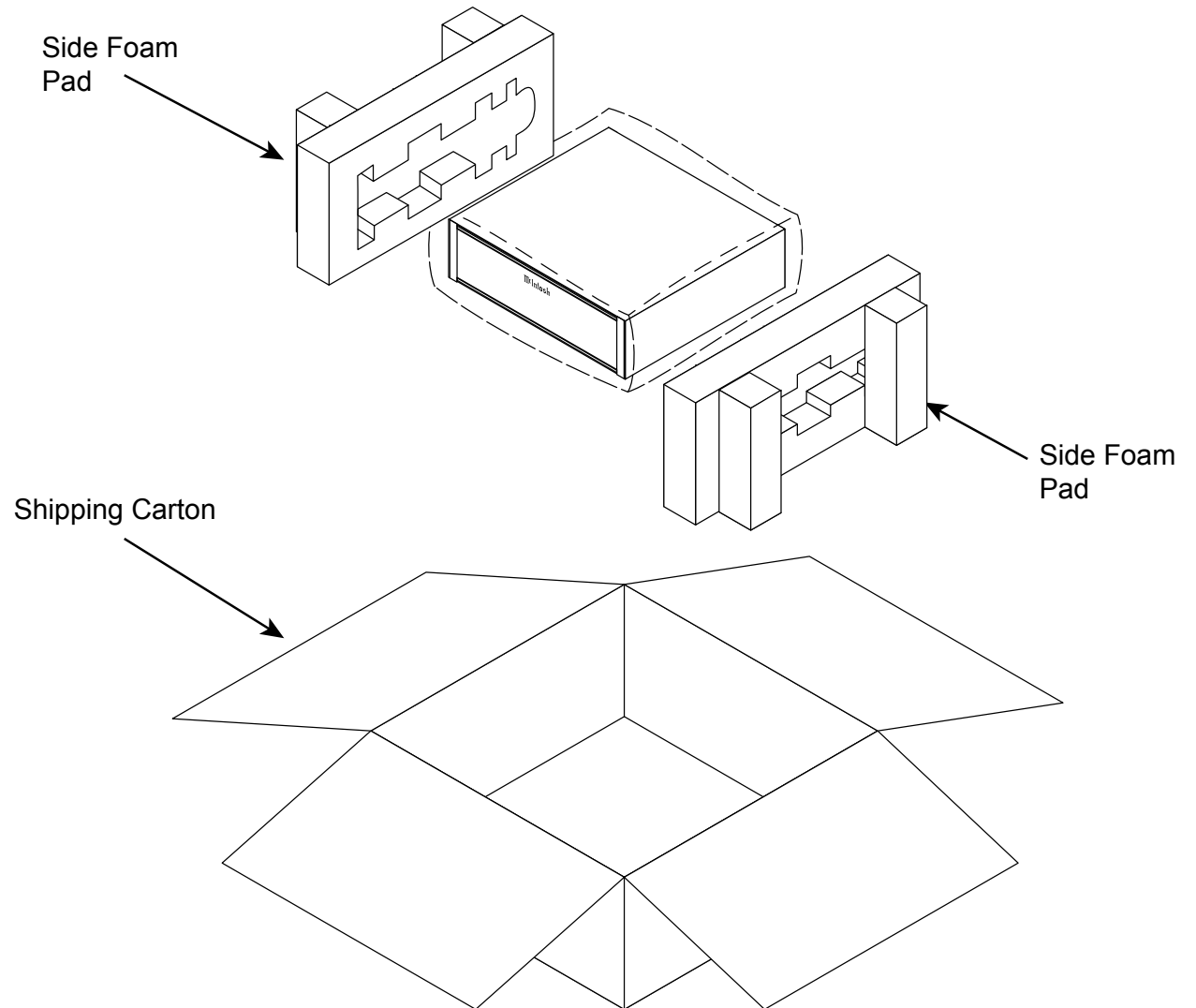



McIntosh Laboratory, Inc.
2 Chambers Street
Binghamton, NY 13903
www.mcintoshlabs.com

The continuous improvement of its products is the policy of McIntosh Laboratory Incorporated who reserve the right to improve design without notice.
Printed in the U.S.A.

McIntosh Part No. 04167500