



McIntosh Laboratory, Inc. 2 Chambers Street Binghamton, New York 13903-2699 Phone: 607-723-3512 www.mcintoshlabs.com

C48
Audio Preamplifier
Owner's Manual



The lightning flash with arrowhead, within an equilateral triangle, is intended to alert the user to the presence of uninsulated “dangerous voltage” within the product’s enclosure that may be of sufficient magnitude to constitute a risk of electric shock to persons.

WARNING - TO REDUCE RISK OF FIRE OR ELECTRICAL SHOCK, DO NOT EXPOSE THIS EQUIPMENT TO RAIN OR MOISTURE.

IMPORTANT SAFETY INSTRUCTIONS!

PLEASE READ THEM BEFORE OPERATING THIS EQUIPMENT.

1. Read these instructions.
2. Keep these instructions.
3. Heed all warnings.
4. Follow all instructions.
5. Do not use this apparatus near water.
6. Clean only with a dry cloth.
7. Do not block any ventilation openings. Install in accordance with the manufacturer’s instructions.
8. Do not install near any heat sources such as radiators, heat registers, stoves, or other apparatus (including amplifiers) that produce heat.
9. Do not defeat the safety purpose of the polarized or grounding-type plug. A polarized plug has two blades with one wider than the other. A grounding type plug has two blades and a



AVIS RISQUE DE CHOC ELECTRIQUE - NE PAS OUVRIR.

NO USER-SERVICEABLE PARTS INSIDE. REFER SERVICING TO QUALIFIED PERSONNEL.

third grounding prong. The wide blade or the third prong are provided for your safety. If the provided plug does not fit into your outlet, consult an electrician for replacement of the obsolete outlet.

10. Protect the power cord from being walked on or pinched particularly at plugs, convenience receptacles, and the point where they exit from the apparatus.
11. Only use attachments/accessories specified by the manufacturer.
12. Use only with the cart, stand, tripod, bracket, or table specified by the manufacturer, or sold with the apparatus. When a cart is used, use caution when moving the cart/apparatus combination to avoid injury from tip-over.
13. Unplug this apparatus during lightning storms or when unused for long periods of time.
14. Refer all servicing to qualified service personnel. Servicing is required when the apparatus has been damaged in any way, such as power-



The exclamation point within an equilateral triangle is intended to alert the user to the presence of important operating and maintenance (servicing) instructions in the literature accompanying the appliance.

To prevent the risk of electric shock, do not remove cover or back. No user-serviceable parts inside.

supply cord or plug is damaged, liquid has been spilled or objects have fallen into the apparatus, the apparatus has been exposed to rain or moisture, does not operate normally, or has been dropped.

15. Do not expose this equipment to dripping or splashing and ensure that no objects filled with liquids, such as vases, are placed on the equipment.
16. To completely disconnect this equipment from the a.c. mains, disconnect the power supply cord plug from the a.c. receptacle.
17. The mains plug of the power supply cord shall remain readily operable.
18. Do not expose batteries to excessive heat such as sunshine, fire or the like.
19. Connect mains power supply cord only to a mains socket outlet with a protective earthing connection.

Thank You

Your decision to own this McIntosh C48 Audio Pre-amplifier ranks you at the very top among discriminating music listeners. You now have “The Best.” The McIntosh dedication to “Quality,” is assurance that you will receive many years of musical enjoyment from this unit.

Please take a short time to read the information in this manual. We want you to be as familiar as possible with all the features and functions of your new McIntosh.

Please Take A Moment

The serial number, purchase date and McIntosh Dealer name are important to you for possible insurance claim or future service. The spaces below have been provided for you to record that information:

Serial Number: _____

Purchase Date: _____

Dealer Name: _____

Technical Assistance

If at any time you have questions about your McIntosh product, contact your McIntosh Dealer who is familiar with your McIntosh equipment and any other brands that may be part of your system. If you or your Dealer wish additional help concerning a suspected problem, you can receive technical assistance for all McIntosh products at:

McIntosh Laboratory, Inc.
2 Chambers Street
Binghamton, New York 13903
Phone: 607-723-3512
Fax: 607-724-0549

Customer Service

If it is determined that your McIntosh product is in need of repair, you can return it to your Dealer. You can also return it to the McIntosh Laboratory Service Department. For assistance on factory repair return procedure, contact the McIntosh Service Department at:

McIntosh Laboratory, Inc.
2 Chambers Street
Binghamton, New York 13903
Phone: 607-723-3515
Fax: 607-723-1917

Table of Contents

Safety Instructions	2
Thank You and Please Take a Moment.....	3
Technical Assistance and Customer Service	3
Table of Contents	3
General Information	4
Connector and Cable Information	4
Introduction.....	5
Performance Features	5
Dimensions	6
Installation	7
Connections:	
Rear Panel Connections	8
(Separate Sheet)	Mc2B
Connecting Components.....	9
Connection Diagrams (Separate Sheets).....	Mc1A, Mc1B and Mc2A
Remote Control:	
Remote Control Push-buttons.....	10
How to use the Remote Control.....	11

Front Panel:

Front Panel Displays, Controls, Push-buttons and Jack.....	12
---	----

Setup:

How to Operate the Setup Mode	13
Default Settings.....	13
Firmware Version.....	13
Source Inputs Reassignment.....	13
Input Level Adjustment	14
Power Mode	15
Display Brightness.....	15
Passthru.....	15
Power Control Triggers 1 and 2	16
Comm Port Baud Rate	16
Remote Control Codes.....	17

Operation:

How to Operate the C48	18
Trim Functions.....	18-20
Equalizer Bypass	21
Equalizer Controls	22
Passthru.....	22
Optical and Digital Inputs.....	23
USB Input Operation with a Computer	23
Reset of Microprocessors.....	23
Resetting the C48 to default settings.....	23

Additional Information:

Photos.....	24-25
Specifications.....	26
Packing Instruction.....	27

Copyright 2010, 2012 © by McIntosh Laboratory, Inc.

General Information

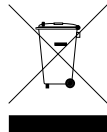
1. For additional connection information, refer to the owner's manual(s) for any component(s) connected to the C48 Audio Preamplifier.
2. The Main AC Power going to the C48 and any other McIntosh Component(s) should not be applied until all the system components are connected together. Failure to do so could result in malfunctioning of some or all of the system's normal operations. When the C48 and other McIntosh Components are in their Standby Power Off Mode, the Microprocessor's Circuitry inside each component is active and communication is occurring between them.
3. Balanced and Unbalanced Inputs and Outputs can be mixed. For example, you may connect signal sources to Unbalanced Inputs and send signals from the Balanced Outputs. You can also use Balanced and Unbalanced Outputs simultaneously, connected to different Power Amplifiers.
4. The C48 internal Digital to Analog Converter Circuitry is designed to decode 2-channel PCM (Pulse Code Modulation) Digital Signal present at the Coaxial and Optical Digital Audio Inputs. Other Digital Audio Signal Format Types will cause the Audio Outputs of the C48 to be muted and the Front Panel Information Display will indicate an error message.
5. The Remote Control Supplied with the C48 Preamplifier is capable of operating other components. For additional information go to www.mcintosh-labs.com.
6. When discarding the unit, comply with local rules or regulations. Batteries should never be thrown away or incinerated but disposed of in accordance with the local regulations concerning battery disposal. 

7. For additional information on the C48 and other McIntosh Products please visit the McIntosh Web Site at www.mcintoshlabs.com.

Connector and Cable Information

XLR Connectors

Below is the Pin configuration for the XLR Balanced Input and Output Connectors on the C48. Refer to the diagrams for connections:

- PIN 1: Shield/Ground
- PIN 2: + Output
- PIN 3: - Output

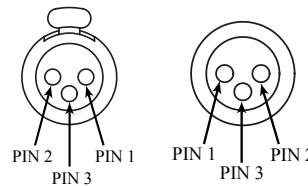

Power Control and Trigger Connectors

The C48 Power Control Out, Trigger and Pass-Thru Output Jacks send Power On/Off Signals (+12 volt/0 volt) when connected to other McIntosh Components. An additional connection is for controlling the illumination of the Power Output Meters on McIntosh Power Amplifiers. A 1/8 inch stereo mini phone plug is used for connection to the Power Control, Trigger and Pass-Thru Outputs on the C48.

Output 1&2, Trig 1&2 and Pass-Thru

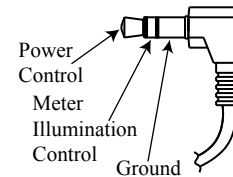

Note: The Power Control, Trigger, Pass-Thru and Data Connecting Cable is available from the McIntosh Parts Department:

Power Control, Trigger, Pass-Thru and Data Cable Part No. 170-202

Six foot, shielded 2 conductor, with 1/8 inch stereo mini phone plugs on each end.

Data Port Connectors

The C48 Data Out Ports send Remote Control Signals to Source Components. A 1/8 inch stereo mini phone plug is used for connection.

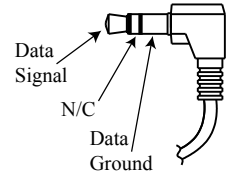

Introduction

The McIntosh C48 Audio Preamplifier is one of the finest Preamplifiers ever created. The versatile Preamplifier provides connections for various input sources both analog and digital. The C48 Outputs have the ability to drive multiple Power Amplifiers. The C48 reproduction is sonically transparent and absolutely accurate. The McIntosh Sound is “The Sound of the Music Itself.”

Performance Features

• Electromagnetic Input Switching with Level Trim Adjustment

Digital Logic integrated circuits drive Electromagnetic Switches on all Inputs and operating functions for reliable, noiseless, distortion free switching. All eight Inputs on the C48 can be matched in level, so there are no abrupt changes in volume levels between the different Inputs.

• Moving Coil and Moving Magnet Phono Inputs

The C48 contains two different precision Phono Preamplifier Circuits. One for low output Moving Coil Phono Cartridges with selectable resistance loading, the other is for Moving Magnet Cartridges with selectable capacitive loading. Both circuits use the latest designs to provide the lowest possible noise and distortion. The RIAA Correction Equalization Circuitry utilizes close tolerance resistors and capacitors for an extremely flat frequency response.

• Digital Audio Inputs

The C48 has Coaxial, Optical and USB Digital Inputs to Decode PCM Signals from an external source. The C48 Up Samples the Digital Signal to 192kHz with 32Bit resolution before the Digital to Analog process begins. The USB Input sends basic commands (e.g.

Play/Pause, Next, Back, etc.) to the computer by using the C48 Remote Control.

• Balanced Inputs

The Balanced Inputs allow the connection of a source component using long cable lengths without a loss in sound quality.

• Precision Tracking Volume Control

Volume levels are controlled by a new Multi-Stage Precision Digitally Controlled Attenuator System with a tracking accuracy of 0.1dB.

• Variable Rate Volume and Balance Controls

The C48 Preamplifier’s Volume and Balance Control Circuitry provides an ideal rate of change with control rotation.

• Equalizer Controls with Bypass

The Equalizer Circuitry provides 12dB of boost or cut at five different center frequencies. When an Equalizer Control is in the center position, all Circuit Components are removed from the Signal Path. The C48 remembers the Equalizer Circuitry Bypass Option for each input.

• Pass-Thru Mode

The Automatic Pass-Thru Mode allows the C48 to become part of a Multichannel Sound System for DVD-Audio, SACD and Home Theater Movies.

• Alphanumeric Fluorescent Display

The Front Panel Information Display indicates the Source Selection, Volume/Balance Levels and Setup Mode Selections. The display intensity is adjustable.

• Remote Control with External Sensor Input

The Remote Control provides control of the C48 operating functions and McIntosh Source Components connected to it. Enjoy your McIntosh System from another room in your home by connecting an external sensor.

• Power Control Output and Trigger Assignment

A Power Control connection for convenient Turn-On of McIntosh Power Amplifiers, Source Components and Accessories is included. The Power Control Trigger Outputs may be assigned to activate when a given Input is selected.

• Special Power Supply

Fully regulated Power Supplies and a special R-Core Power Transformer ensure stable noise free operation even though the power line varies.

• Fiber Optic Solid State Front Panel Illumination

The even Illumination of the Front Panel is accomplished by the combination of custom designed Fiber Optic Light Diffusers and extra long life Light Emitting Diodes (LEDs).

• Glass Front Panel and Super Mirror Chassis Finish

The famous McIntosh Illuminated Glass Front Panel and the Stainless Steel Chassis with Super Mirror Finish ensures the pristine beauty of the C48 will be retained for many years.

Dimensions

The following dimensions can assist in determining the best location for your C48. There is additional information on the next page pertaining to installing the C48 into cabinets.

Front View of the C48

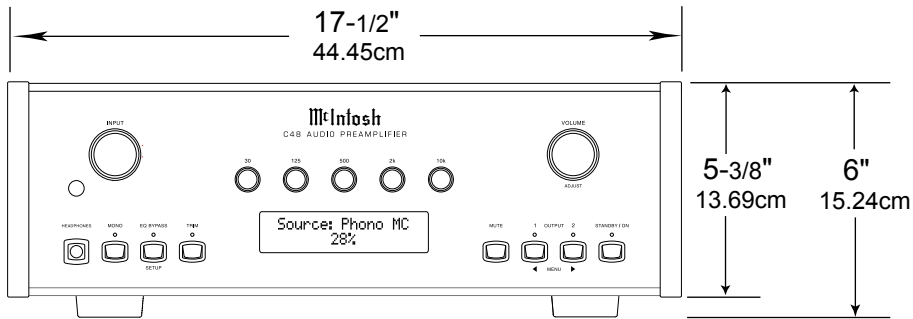

Rear View of the C48

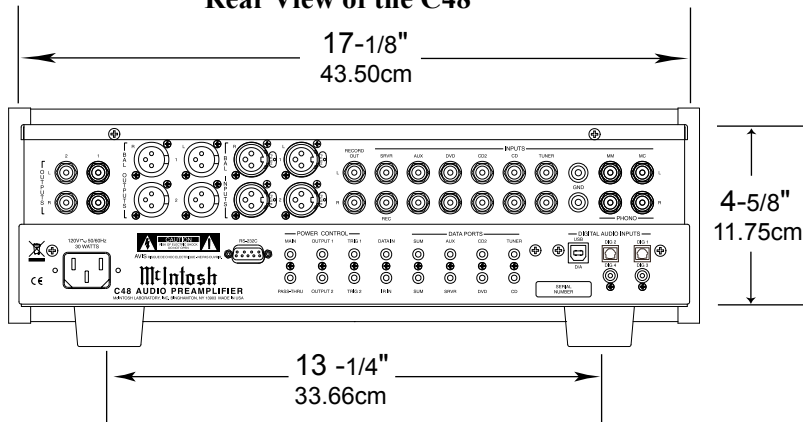

Side View of the C48

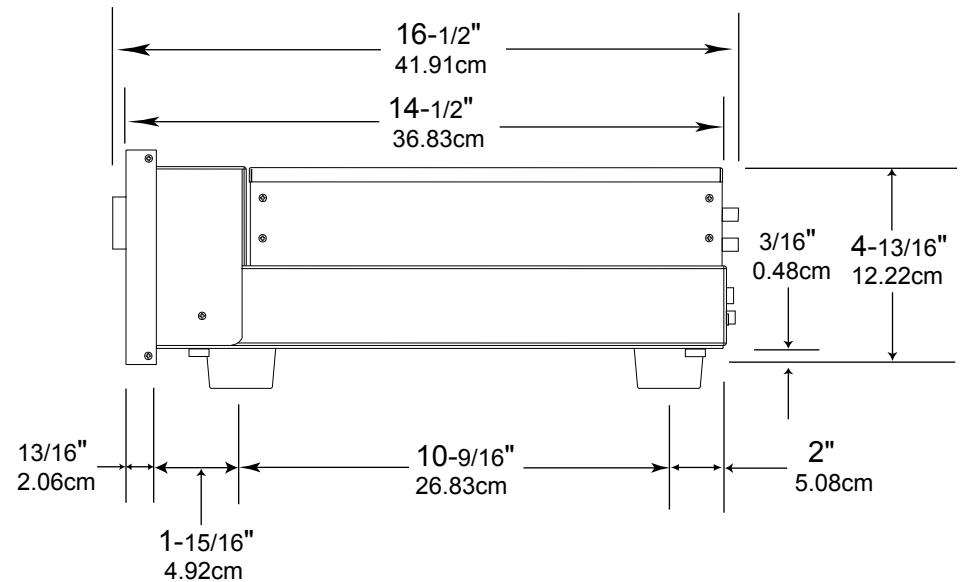

Installation

The C48 can be placed upright on a table or shelf, standing on its four feet. It also can be custom installed in a piece of furniture or cabinet of your choice. The four feet may be removed from the bottom of the C48 when it is custom installed as outlined below. The four feet together with the mounting screws should be retained for possible future use if the C48 is removed from the custom installation and used free standing. The required panel cutout, ventilation cutout and unit dimensions are shown.

Always provide adequate ventilation for your C48. Cool operation ensures the longest possible operating life for any electronic instrument. Do not install the C48 directly above a heat generating component such as a high powered amplifier. If all the components are installed in a single cabinet, a quiet running ventilation fan can be a definite asset in maintaining all the system components at the coolest possible operating temperature.

A custom cabinet installation should provide the following minimum spacing dimensions for cool operation.

Allow at least 2 inches (5.08cm) above the top, 2 inches (5.08cm) below the bottom and 1 inch (2.54cm) on each side of the Preamplifier, so that airflow is not obstructed. Allow 20 inches (50.8cm) depth behind the front panel. Allow 1-7/16 inch (3.66cm) in front of the mounting panel for knob clearance. Be sure to cut out a ventilation hole in the mounting shelf according to the dimensions in the drawing.

**C48 Front Panel
Custom Cabinet Cutout**

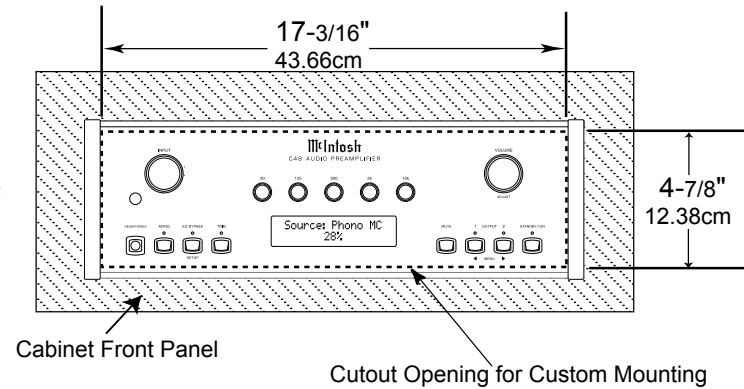

**C48 Side View
in Custom Cabinet**

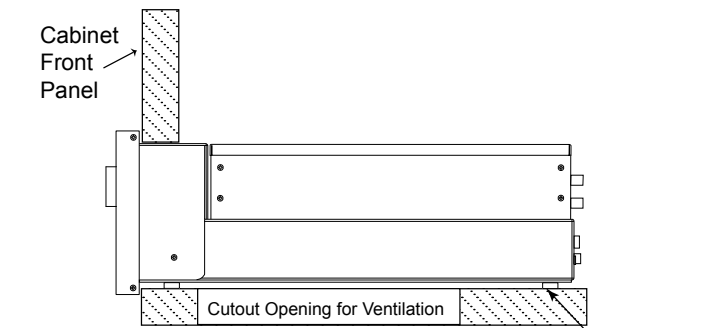

**C48 Bottom View
in Custom Cabinet**

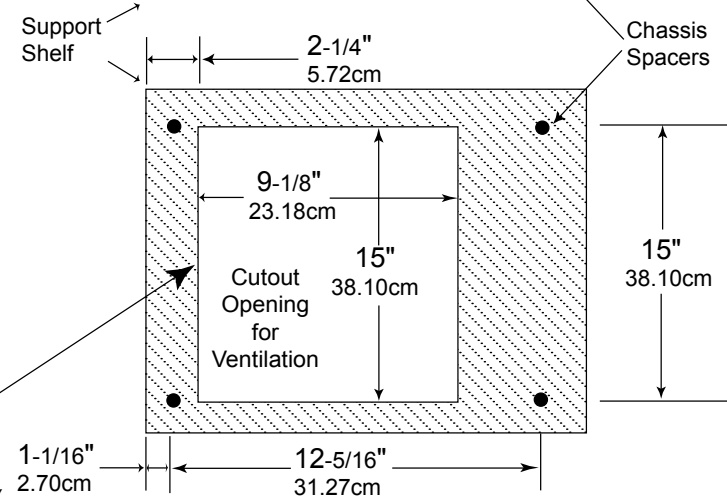

Note: Center the cutout Horizontally on the unit. For purposes of clarity, the above illustration is not drawn to scale.

Rear Panel Connections

The identification of Rear Panel Connections for the C48 Audio Preamplifier is located on a separate folded sheet contained in the Owner's Manual Packet. Refer to separate sheet "Mc2B" for the Rear Panel Connections.

C48 Audio Preamplifier Rear Panel

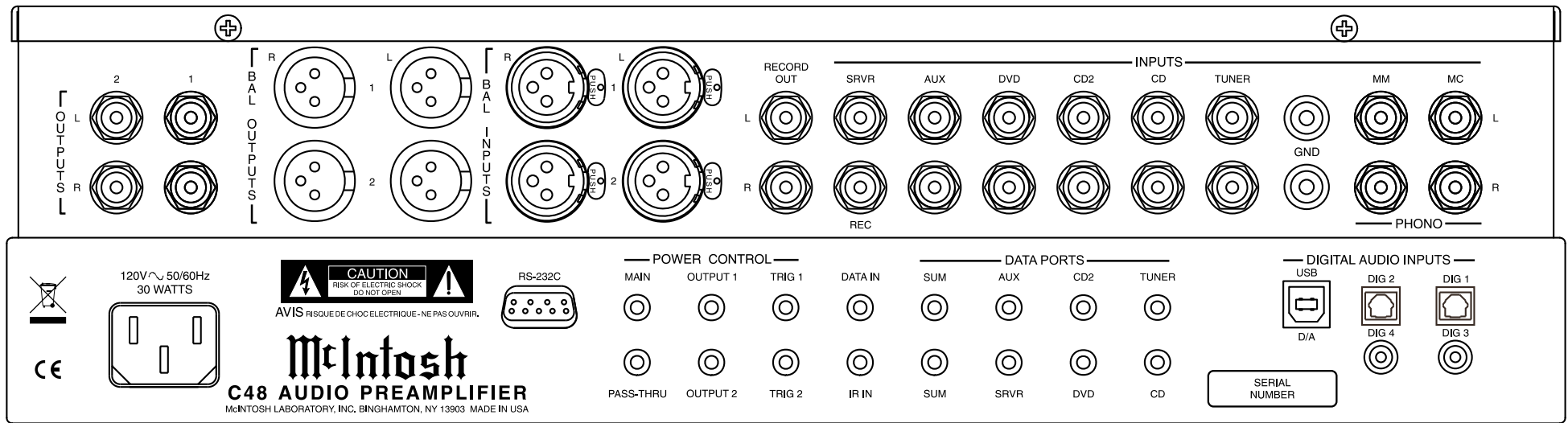

Connecting Components

The C48 has the ability to automatically switch power On/Off to Source Components via the Power Control connections. The Data Port Connections allow for the remote operation of basic functions using the C48 Remote Control. With an external sensor connected to the C48, remote control operation of the system is possible from another room and/or when the C48 is located in a cabinet with the doors closed.

The connection instructions below, together with the C48 Input/Output/Control Connection Diagrams located on the separate folded sheets “Mc1A/1B and Mc2A”, are an example of a typical audio system. Your system may vary from this, however the actual components would be connected in a similar manner. For additional information refer to “Connector and Cable Information” on page 4.

Note: Source components may be connected to the C48 Balanced Inputs or Digital Inputs instead of Unbalanced Inputs. Refer to Setup “Reassigning Inputs” to activate them on page 13.

Power Control Connections:

1. Connect a Control Cable from the C48 POWER CONTROL MAIN Jack to the Power Control In on the Turntable.
2. Connect a Control Cable from the Turntable Power Control Out Jack to the SACD/CD Player Power Control In Jack.
3. Connect a Control Cable from the SACD/CD Player Power Control Out Jack to the Tuner Power Control In Jack.
4. Connect a Control Cable from the Tuner Power Control Out Jack to the Music Server Power Control In Jack.
5. Connect a Control Cable from the C48 POWER CONTROL OUTPUT 1 Jack to the Power Amplifier Power Control In Jack.

Note: If two Power Amplifiers are used, connect the Power Control Output of the first Amplifier to the Power Control Input on the second Amplifier.

6. Optionally connect a Control Cable from the C48 POWER CONTROL OUTPUT 2 Jack to the Power Amplifier (Secondary Room) Power Control In Jack.
7. Connect any additional Components in a similar manner, as outlined in steps 1 thru 4.

Data Control Connections:

8. Connect a Control Cable from the C48 TUNER DATA PORTS Jack to the TUNER Data In Jack.
9. Connect a Control Cable from the C48 CD DATA PORT Jack to the SACD/CD Player Data In Jack.
10. Connect a Control Cable from the C48 SRVR DATA PORT Jack to the Music Server Data In Jack.
11. Connect any additional McIntosh Components in a similar manner, as outlined in steps 8 thru 10.

Sensor Connection:

12. Connect a Control Cable from the C48 IR Input Connector to the external Sensor.

Audio Connections:

13. Connect an Audio Cable from the C48 TUNER INPUT Jacks to the Tuner (Fixed) Output Jacks.
14. Connect an Audio Cable from the C48 CD INPUT Jacks to the SACD/CD Player (Fixed) Output Jacks.
15. Connect an Audio Cable from the C48 SRVR INPUT Jacks to the Music Server Output Jacks.
16. Connect an Audio Cable from the C48 RECORD OUTPUT Jacks to the Music Server Input 3 Jacks.
17. Connect the Audio Cables coming from the Turntable to the C48 MC PHONO INPUT Jacks.

Note: If the Turntable has a Moving Magnet Cartridge connect the audio cables to the C48 MM PHONO INPUT instead of the MC Input.

18. Connect Balanced Cables from the C48 BALANCED OUTPUT 1 connectors to the Power Amplifiers Balanced (Left and Right) Inputs.
19. Optionally Connect an Audio Cable from the C48 BALANCED OUTPUT 2 connectors to the Power Amplifier (Secondary) Inputs.
20. Connect any additional McIntosh Components in a similar manner, as outlined in steps 14 thru 18.

Optional “PassThru” Connections:

21. Connect Balanced Cables from the A/V Control Center Front Left and Right Channel Balanced Output connectors to the BALANCED 2 Input connectors.
Note: Refer to Setup “PassThru” on page 15 to activate the BALANCED 2 Input.
22. Connect a Control Cable from the C48 PASSTHRU to A/V Control Center Zone ZA Power Control Output.

Optional USB Connection:

23. Connect a USB cable with (type A to type B) connectors from the C48 USB D/A Input to an available USB connector.

Ground Connections:

24. Connect the Ground Cable coming from the Turntable to the C48 GND Binding Post.

AC Power Cords Connections:

25. Connect the C48 and any remaining components’ AC Power Cords to a live AC outlet as illustrated.

LED illuminates during the time a remote command is sent to the C48

Switches the Trigger 1 and/or 2 Power Control Jack(s) On/Off, refer to "Setup, Power Control TRIG 1 and TRIG 2" on page 15 for additional information

Selects a Disc Player, Music Server or Recorder Function. Seek Stations Up or Down the AM/FM Dial. Select AM/FM Station Presets and performs various functions on a variety of McIntosh Components

Displays On Screen Functions on the McIntosh Music Server and a variety of other McIntosh Components

Adjusts the volume level up or down

Mutes the audio

Selects AM Tuner Operating Functions and Disc Selection on certain McIntosh Disc Players

Functions as a "shift" key when used with the AM or FM push-buttons to select Output 1 or 2

Scrolls through the available C48 Inputs

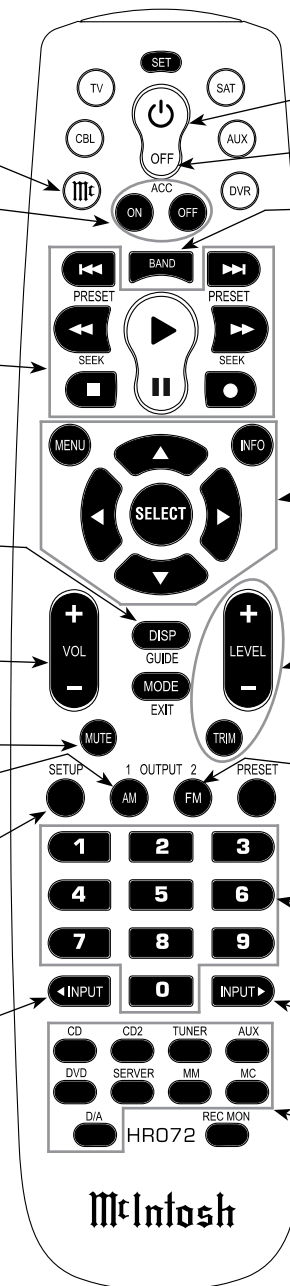

Press to Power the C48 ON

Press to Power the C48 OFF

Press to change broadcast bands on an external McIntosh Tuner connected. Select certain functions on a variety of McIntosh Components

Selects On Screen Functions on a variety of McIntosh Components

Press TRIM and then the LEVEL Push-buttons to select and adjust various functions

Selects FM Tuner Operating Functions and Track Selection on certain McIntosh CD Players

Use to select tuner presets, disc tracks or any numbered operation

Scrolls through the available C48 Inputs

Selects one of the eight available Audio Sources

Note: Push-buttons whose function is not identified above are for use with other McIntosh Products.

How to use the Remote Control

The supplied HR072 Remote Control is capable of directly controlling the functions of contemporary Source Components connected to the C48 via the Data Ports.

Note: If at any time the C48 seems unresponsive to HR072 Remote Control Commands press the  Push-button first.

Input Source Selection

Press the appropriate Source Push-button to select the desired program source.

Note: When the C50 is Off, pressing one of the Source Push-buttons will switch the C50 On and will go to that Input.

Mute

Press the MUTE Push-button to mute the audio in all outputs except the REC OUTPUT. The word MUTE will appear on the Front Panel Information Display. To un-mute the audio, press the MUTE Push-button again.

Disc, Server and Tape Functions

Use these push-buttons to operate a DVD Player, CD Player, CD Changer, Music Server or Recorder.

Numbered Push-buttons

Press Push-buttons 0 through 9 to access tuner station presets, tracks on discs or selections on a Music Server.

Disc and Track

Use the AM (disc) and FM (track) Push-buttons when a Disc Player or Music Server is being used.

Tuner Push-buttons

Press the AM or FM Push-button to select the desired broadcast band. Press and release the Channel Up ▲ or Down ▼ Push-button to seek the next available station. Press and hold a Channel Up ▲ or Down ▼ Push-button to seek continuously from station to station.

Volume

Press the Up ▲ or Down ▼ VOLUME Push-button to raise or lower the listening volume level.

Note: The Record Signals present at REC OUTPUTS are not affected by volume changes.

Pause

Press the Pause  Push-button to perform various functions on a variety of McIntosh Components. It will also pause the playing of a disc or tape player.

Trim

Press the TRIM Push-button until the desired Trim function (Balance, Trim Level, etc.) appears on the Front Panel Information display, then press the LEVEL Up ▲ or Down ▼ Push-button to adjust the Trim setting.

Note: Press the TRIM Push-button to recall the last Trim function selected. For additional information on the Trim Functions refer to pages 18, 19 and 20.

Amplifier Selection

Press the BLUE (Setup) Push-button followed by the AM (Output 1) or FM (Output 2) Push-button, to control the rear panel Audio OUTPUTS 1, 2 (ON or OFF) and Power Control OUTPUT 1 / OUTPUT 2. These OUTPUTS provide signals to a Power Amplifier or other accessory component.





Front Panel Displays, Controls, Push-buttons and Jack

IR Sensor receives commands from a Remote Control

INPUT Control allows the selection of various sources for listening and recording

EQUALIZER Controls increase or decrease the volume levels at the Center Frequencies of 30Hz, 125Hz, 500Hz, 2,000Hz, and 10,000Hz

VOLUME Control allows adjustment of the listening level for both channels

Connection for low impedance dynamic headphones, for private listening

MONO with indicator, combines the Left and Right Channel signals for Monophonic Sound

EQUALIZER BYPASS Push-button with indicator, when activated the audio signal bypasses the Equalizer Controls, also used to enter and exit the Setup Mode

TRIM Push-button with indicator, allows selection of various types of settings

INFORMATION DISPLAY indicates the Sources, Volume, other Audio Settings, Operational Functions and Setup Mode Settings

MUTE Push-button mutes the audio from the Loudspeakers and Headphones

OUTPUT 1 and 2 Push-buttons with indicators, switch the Preamplifier Outputs 1 and 2 On or Off

STANDBY/ON Push-button with indicator, switches the C48 ON or OFF (Standby) and resets the microprocessors

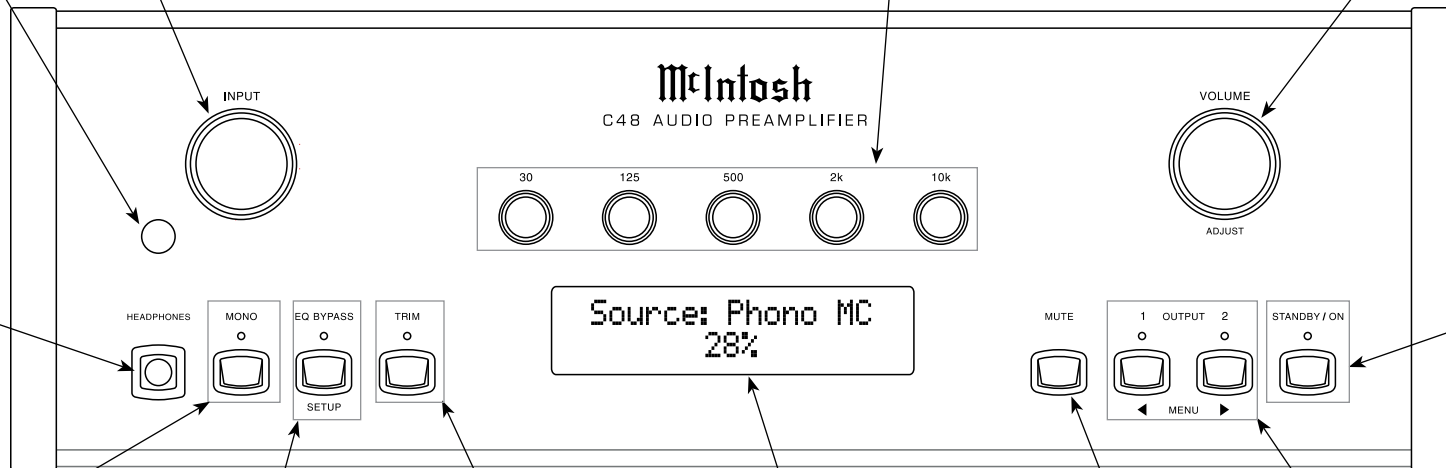

How to Operate the Setup Mode

Your McIntosh C48 has been factory configured for default operating settings that will allow immediate enjoyment of superb audio without the need for further adjustments. If you wish to make changes to the factory default settings, a Setup Feature is provided to customize the operating settings using the Front Panel Information Display. Refer to the C48 Front Panel Illustration on the previous page while performing the following steps.

Note: If the C48 is currently On, proceed to step 2.

1. Press the STANDBY/ON Push-button on the Front Panel or press the  (Power) Push-button on the Remote Control to switch On the C48. The C48 will go through a brief startup initialization with the Front Panel Information Display indicating the last used source and volume setting, this is followed by the volume setting indication starting at zero and then increasing to the last used volume setting. Refer to figure 1.





Figure 1

2. Press and hold the EQ BYPASS/SETUP Push-button until the Front Panel Information Display indicates "McIntosh C48, V1.00 - 1.0 or higher Firmware. Refer to figure 2. At this time the LED



Figure 2

3. Press the OUTPUT 2 / MENU  Push-button to select the next Setup Mode Menu item, "SETUP: SOURCE INPUT, TUNER : RCA". With each additional press of the OUTPUT 2 / MENU 

Push-button the Setup Menu will advance to the next Menu Selection. Refer to figure 3.

Figure 3

4. To exit from the Setup Mode, press the EQ BYPASS/SETUP Push-button. The LED above the TRIM Push-button will extinguish and the Front Panel Display will revert back to its normal display. Refer to figure 1.

Default Settings

The Default Settings Chart below indicates the Function Name, Default Setting and the Page Number for additional information.

Default Settings		
Function Name	Setting	Page No.
McIntosh C48	V_ _ - _ _	13
SOURCE INPUT (connector type)	RCA	13
LEVEL (Trim)	0.0dB	14
POWER MODE (Auto Off)	ENABLED	15
DISPLAY (Brightness)	3	15
PASSTHRU	OFF	15
TRIG 1 Output (Action)	MAIN	16
TRIG 2 Output (Action)	MAIN	16
COMM PORT (Baud Rate)	115200	17
REMOTE (Codes)	NORM	17

Default Settings		
PHONO CARTRIDGE (Moving Coil)	500 Ohms	20
PHONO CARTRIDGE (Moving Magnet)	50 pF	20

Firmware Version

The C48 functionality is controlled by internal software that is known as Firmware. The Version of the Firmware in the C48 can be identified at any time by utilizing the Setup Mode.

1. Press and hold the C48 Front Panel EQ BYPASS/SETUP Push-button to enter the Setup Mode.
2. The number after the character "V" is the Firmware number. Refer to figure 2.
3. To exit the Setup Mode, press the EQ BYPASS/SETUP Push-button.

Source Inputs Reassignment

The C48 provides the ability to reassign the non-Phono Inputs (High Level) to either one of two Balanced Inputs or one of the four Digital Inputs. In the first example, the CD2 Input will be reassigned from the unbalanced CD2 (RCA Jacks) to the BALANCED 1 (XRL Connector).

- Notes:*
1. Any one of the Default Inputs may be switched Off. If any input is switched Off its name will no longer appear on the Front Panel Information Display when using the INPUT Control, nor is it accessible with the Remote Control.
 2. The Phono MC (Moving Coil) and MM (Moving Magnet) Input are designed for connection of a turntable only and thus non-reassignable. However, the Phono Inputs may be switched Off.

Reassign Source Inputs, con't

3. Only one Input may be assigned at a time to a Balanced (1 & 2) or Digital (1 thru 4) Connector. If an already assigned Balanced or Digital connector is to be reassigned to a different Input, the Input currently assigned to the connector first needs to be changed. It can be set to a RCA connector or to another available Balanced or Digital connector.

1. Press and hold the EQ BYPASS/SETUP Push-button until the Setup Mode is active. Then press the OUTPUT 2 / MENU ► Push-button to select the Setup Menu item “SETUP: SOURCE INPUT, TUNER :RCA”. Refer to figure 4.

Figure 4

2. Rotate the INPUT Control until “CD2 : RCA” appears on the Front Panel Information Display. Refer to figure 5.

Figure 5

3. Rotate the VOLUME/ADJUST Control until “CD2 : BALANCED 1” appears on the Front Panel Information Display. Refer to figure 6.

Figure 6

The second example will illustrate reassigning the SRVR (Server) Input from SRVR/REC Input (RCA Jacks) to the DIGital 1 Optical Input.

4. Rotate the INPUT Control until “SRVR : RCA” appears on the Front Panel Information Display. Refer to figure 7.

Figure 7

5. Rotate the VOLUME/ADJUST Control until “SRVR : DIGITAL 1” appears on the Front Panel Information Display. Refer to figure 8. Record

Figure 8

any changes made to the various inputs from the default settings in the “Input and Power Control Settings” chart for future reference.

6. To exit from the Setup Mode, press the EQ BYPASS/SETUP Push-button.

Input Level Adjustment

Source Components can have slightly different volume levels resulting in the need to readjust the C48 Volume Control when switching between different sources. The C48 allows the adjustment of levels for each of the Source Inputs for the same relative volume. The CD and SERVER Inputs are used in the following example.

Note: The range of adjustment is ± 6 dB. The signal Level present at the RECORD OUT Jacks is unaffected by any changes in the Setup Level adjustment. The level adjustments made are retained in permanent memory. They can be changed during operation of the C48 by performing a Trim Level Procedure, refer to page 19 for additional information.

1. Rotate the INPUT Control to select the CD Input and adjust the VOLUME Control to the desired listening level.
2. Press and hold the EQ BYPASS/SETUP Push-button until the Setup Mode is active. Then press

the OUTPUT 2 / MENU ► Push-button until the Setup Menu item “LEVEL: CD 0.0dB” appears on the Front Panel Information Display. Refer to figure 9.

Figure 9

Note: The CD Input is serving as a reference level or choose another source frequently listened to. The Input Source should be set to a reference Level (Trim) of 0.0dB.

3. Rotate the INPUT Control until “LEVEL: SRVR 0.0dB” appears on the Front Panel Information Display. If necessary, rotate the VOLUME/ADJUST Control to obtain the same volume level as the CD Input by switching between the two Inputs using the INPUT Control.
4. Rotate the INPUT Control until “LEVEL: SRVR _.” appears on the Front Panel Information Display. The illustration in figure 10 indicates a

Figure 10

-2.5dB decrease in the SRVR Level to match the volume level of the CD Input.

5. Repeat step 4 for other Inputs with component sources connected until they all have the same relative volume levels. Record any changes made to the various inputs from the default settings in the “Input and Power Control Settings” chart below.
6. To exit from the Setup Mode, press the EQ BYPASS/SETUP Push-button.

Input and Power Control Settings				
Input Name	Connection Type	New Level (Trim)	Triggers	
			1	2
TUNER				
CD				
CD2				
DVD				
AUX				
SRVR (Rec)				
PHONO MC				
PHONO MM				

Power Mode

The C48 incorporates an Auto Off Feature, which automatically places the preamplifier into the Power Saving Standby/Off Mode. This occurs approximately 2 hours after there has been an absence of user activity (includes changes to any of the Operation Functions such as source selection, volume adjustment, etc). If it is desirable to disable the Auto Off Feature perform the following steps:

1. Press and hold the EQ BYPASS/SETUP Push-button until the Setup Mode is active. Then press the OUTPUT 2 / MENU ► Push-button until the Setup Menu item “SETUP: POWER MODE, Auto Off: Enabled” appears on the Front Panel Alphanumeric Display. Refer to figure A.



Figure A

2. Rotate the VOLUME/ADJUST Control until “SETUP: POWER MODE, Auto Off: Disabled”

appears on the Front Panel Alphanumeric Display. Refer to figure B.



Figure B

3. Press the EQ BYPASS/SETUP Push-button to exit the Setup Mode.

Display Brightness

The Front Panel Information Display Brightness may be changed from the default setting. There are four brightness settings for the Information Display. The Display Brightness setting may be varied 1 (Dim) to 4 (Bright). Follow the steps below for reducing the Display Brightness.

1. Press and hold the EQ BYPASS/SETUP Push-button until the Setup Mode is active. Then press the OUTPUT 2 / MENU ► Push-button until the Setup Menu item “SETUP: DISPLAY” appears on the Front Panel Information Display. Refer to figure 11.



Figure 11

2. Rotate the VOLUME/ADJUST Control until “BRIGHTNESS: 1” appears on the Front Panel Information Display. Refer to figure 12.



Figure 12

3. To exit from the Setup Mode, press the EQ BYPASS/SETUP Push-button.

Passthru

The C48 can be part of a Multichannel Sound System for SACD, DVD-Audio and Home Theater. The Right and Left Front Channels from an Audio/Video Control Center or Surround Decoder can “Passthru” the C48 and onto its associated Power Amplifier(s). The Setup Mode allows the activation of the Passthru Mode and the selection of the specified C48 Input Connector to be used for the Right and Left Front Channels. In the example below, the Right and Left Front Channels from the Audio/Video Control Center will be connected to the BALANCED 2 Input Connectors on the C48. Refer to page 9 for additional connection information.

Notes: 1. The Phono Input Connectors and Digital Input Connectors are not assignable as a Passthru Input.

2. *If Balanced Input Connectors 1 and/or 2 are already reassigned to a given Input, they will not appear in the list of available Inputs for the Passthru Mode.*
3. *When one of the RCA Inputs is selected as a Passthru Input, it is advisable to remove it from the list of available Inputs by switching it Off. Refer to “Source Inputs Reassignment” starting on page 13.*

1. Press and hold the EQ BYPASS/SETUP Push-button until the Setup Mode is active. Then press the OUTPUT 2 / MENU ► Push-button until the Setup Menu item “SETUP: PASSTHRU, Source: OFF” appears on the Front Panel Alphanumeric Display. Refer to figure 13.



Figure 13

2. Rotate the VOLUME/ADJUST Control until “SETUP: PASSTHRU, Source: BALANCED 2”

Passthru, con't

appears on the Front Panel Alphanumeric Display. Refer to figure 14.

Figure 14

3. Press the EQ BYPASS/SETUP Push-button to exit the Setup Mode.

Power Control Triggers 1 and 2

By default the Power Control TRIGGER 1 and TRIGGER 2 Outputs function the same as the MAIN Power Control Jack, switching On/Off with the C48. Trigger 1 and 2 are also reassignable to activate when the ACC ON/OFF Push-buttons on the Remote Control are used or when a given Input or Inputs are selected.

In the first example, the Power Control Trigger 1 Output will be set to function via the Remote Control ACC Push-buttons.

1. Press and hold the EQ BYPASS/SETUP Push-button until the Setup Mode is active. Then press the OUTPUT 2 / MENU ► Push-button until the Setup Menu item “SETUP: TRIG1 OUTPUT, Action: MAIN” appears on the Front Panel Information Display. Refer to figure 15.

Figure 15

2. Rotate the VOLUME/ADJUST Control until “Action: REMOTE” appears. Refer to figure 16.

Figure 16

3. Press the EQ BYPASS/SETUP Push-button to exit the Setup Mode.

The second example will use selection of the Tuner Input to switch the Trigger 1 Output On.

4. Press and hold the EQ BYPASS/SETUP Push-button until the Setup Mode is active. Then press the OUTPUT 2 / MENU ► Push-button until the Setup Menu item “SETUP: TRIG1 Output, Action: MAIN” appears on the Front Panel Information Display. Refer to figure 15.
5. Rotate the VOLUME/ADJUST Control until “Action: SOURCE” appears. Refer to figure 17.

Figure 17

6. Then press the OUTPUT 2 / MENU ► Push-button until the Setup Menu item “SETUP: TRIG1 OUTPUT, Source: _____ OFF” appears on the Front Panel Information Display. Refer to figure 18.

Figure 18

Note: By default all the Source Inputs are set to Off.

7. Rotate the INPUT Control to select the Tuner as the source. Refer to figure 18.
8. Rotate the VOLUME/ADJUST Control until “Source: Tuner ON” appears. Refer to figure 19.

Figure 19

9. Press the EQ BYPASS/SETUP Push-button to exit the Setup Mode.

Comm Port Baud Rate

The C48 may be remotely controlled from other equipment connected to the Rear Panel RS232C connector. The speed at which the C48 communicates (8 bit, no parity and 1 stop bit) with other equipment is adjustable from 9,600 bits per second to 115,200 bits per second. To change from the default speed of 115,200 bits per second, perform the following steps:

1. Press and hold the EQ BYPASS/SETUP Push-button until the Setup Mode is active. Then press the OUTPUT 2 / MENU ► Push-button until the Setup Menu item “SETUP: COMM PORT BAUD RATE: 115200” appears on the Front Panel Information Display. Refer to figure 20.

Figure 20

2. Rotate the VOLUME/ADJUST Control to select the desired speed.
3. Press the EQ BYPASS/SETUP Push-button to exit the Setup Mode.

Remote Control Codes

The Remote Control included with the C48 utilizes the NORMal McIntosh Control Codes. The Second Set of Control Codes the C48 will respond to is referred to as the ALternate Codes. The ALternate Codes are used when the C48 is used in the same location as another McIntosh Preamplifier and/or A/V Control Center. This will prevent the Remote Control from affecting the operation of both units at the same time. To activate the Remote Control ALternate Codes perform the following steps:

1. Press and hold the EQ BYPASS/SETUP Push-button until the Setup Mode is active. Then press the OUTPUT 2 / MENU ► Push-button until the Setup Menu item "SETUP: REMOTE, CODES: NORM" appears on the Front Panel Information Display. Refer to figure 21.



Figure 21

2. Rotate the VOLUME/ADJUST Control until "CODES: ALT" appears on the Front Panel Information Display. Refer to figure 22.



Figure 22

3. Press the EQ BYPASS/SETUP Push-button to exit the Setup Mode.
4. To change the C48 Remote Control to the Alternate Codes perform the following steps:
 - A. Press the "Mc" Push-button.
 - B. Press the SET Push-button until the "Mc" Push-button flashes twice.

- C. Press the 3, 2, 4, 2 and 9 Push-buttons within 5 seconds.
 - D. The "Mc" Push-button flashes twice.

Note: To reset the Remote Control to normal codes perform steps A and B then enter 3, 2, 4, 2 and 8 for step C.
5. Press the VOLUME UP/DOWN Push-button on the Remote Control to verify proper operation.





How to Operate the C48

Power On and Off

The Red LED above the STANDBY/ON Push-button lights to indicate the C48 is in Standby mode. To switch ON the C48, press the STANDBY/ON Push-button on the Front Panel or the  (Power On) Push-button on the Remote Control. The C48 will go through a brief startup initialization with the Front Panel Information Display indicating the last used source and volume setting, this is followed by the volume setting indication starting at zero and then increasing to the last used volume setting. Refer to figures 50, 51, 52 and 53. To switch OFF the C48 press the STANDBY/ON Push-button on the Front Panel or the OFF Push-button on the Remote Control.

Note: For an explanation of the Remote Control Push-button functions, refer to pages 10 and 11.



Figure 51

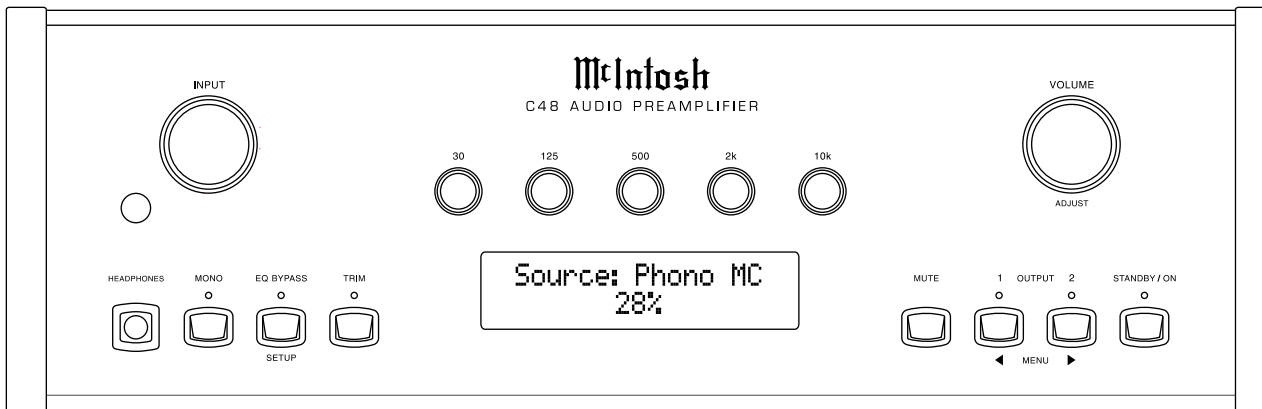

Figure 50



Figure 52

Source Selection

Rotate the INPUT Control to select the desired source or press the appropriate push-button on the Remote Control. Refer to figures 50 and 53.

Volume Control

Rotate the Front Panel VOLUME Control or use the VOLUME Up▲ or Down▼ Push-buttons on the Remote Control for the desired listening level. Refer to figures 50 and 53.

Trim Functions

The C48 has seven different Trim Selections with Adjustments. The Trim Selections include Balance, Trim Level, Amplifier Meter Backlight, Equalizer Mode, Mono/Stereo Mode, Digital Audio Display Info and Phono Cartridge Loading. The Trim Settings are

stored in memory independently for each Input Source Selected, except the Amplifier Illumination and Digital Audio Display settings of On or Off, which are the same for all inputs.

Note: Selection and Adjustment of all Trim Functions may be performed using the Front Panel TRIM, OUTPUT 1/OUTPUT 2 / ◀ MENU ▶ Push-buttons together with the VOLUME/ADJUST Control. The Remote Control TRIM Push-Button together with the LEVEL + / - Push-button may also be used. Refer to figures 50 and 53.

BALANCE

Listening balance varies with different program sources, room acoustics and listening positions relative to the Loudspeakers. Use the Balance (Trim Function) as needed to achieve approximately equal listening volume levels in each Loudspeaker. To adjust the Bal-



Figure 54

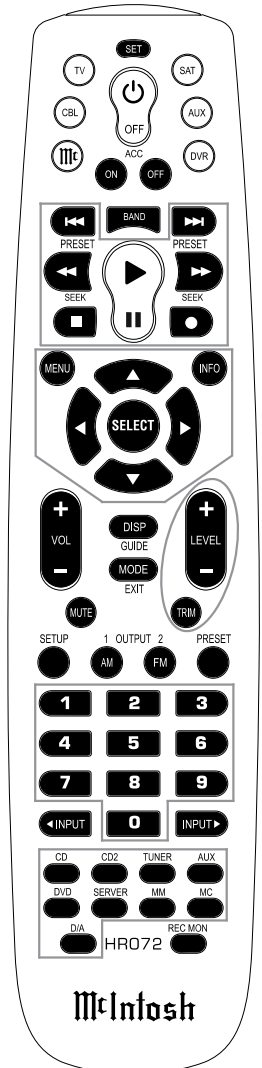

Figure 53

ance perform the following:

1. Press the TRIM Push-button repeatedly on the Remote Control until “BALANCE 0 dB” appears on the Front Panel Information Display. Refer to figure 54.

Note: The Front Panel TRIM Push-button together with the OUTPUT 1/ OUTPUT 2 / ◀ MENU ▶ Push-buttons may also be used.

2. Rotate the VOLUME/ADJUST Control or press the LEVEL + / - Push-buttons on the Remote Control to emphasize the Right Channel (refer to figure 55) or the Left Channel (refer to figure 56).



Figure 55



Figure 56

The Front Panel Display indicates the Balance changes in steps from 0 to 50dB. After approximately 4 seconds the Information Display returns to indicate the Source Selection and Volume Level. To verify the Balance setting without changing it, use the TRIM Push-button and select Balance.

TRIM LEVEL

The Trim Level adjustments allow for making fine adjustments to the previously performed Trim Level Adjustments (refer to the Setup Section of this Owner’s Manual on page 14 for additional information). To make a fine adjustment to the currently selected Input Source perform the following:

1. Select “TRIM LEVEL” as indicated on the Front Panel Information Display. Refer to figures 50, 53 and 57.



Figure 57

2. Adjust the Trim Level to -2.5dB. Refer to figure 58.



Figure 58

After approximately 4 seconds the Information Display returns to indicate the Source Selection and Volume Level.

METER ILLUMINATION

The Front Panel Meter Illumination of recent McIntosh Power Amplifiers may be switched On or Off by performing the following:

1. Select “AMP METER BACKLIGHT, Lights: On” as indicated on the Front Panel Information Display. Refer to figures 50, 53 and 59.



Figure 59

2. Switch On or Off the Amplifier Meter Illumination. Refer to figure 60.



Figure 60

After approximately 4 seconds the Information Display returns to indicate the Source Selection and Volume Level.

EQUALIZER MODE

The built-in five band Frequency Equalizer provides more precise adjustment of sound than Bass and Treble Controls. By default the Equalizer is active for all Input Sources however, any Input Source may be assigned to bypass the Equalizer. To bypass the Equalizer for a given Input Source, perform the following steps:

Note: The audio signal present at the RECORD OUT Jacks is unaffected by the Equalizer settings.

1. Select the desired Input Source.
2. Select “EQUALIZER MODE, _____: Enable” as indicated on the Front Panel Information Display. Refer to figure 61.



Figure 61

3. Set the EQUALIZER MODE to be either enabled or bypassed. Refer to figure 62.



Figure 62

After approximately 4 seconds the Information Display returns to indicate the Source Selection and Volume Level.

MONO/STEREO MODE

By default the Stereo Mode is active for all Input Sources however, any Input Source may be assigned to Mono Mode. To change Stereo Mode to Mono for a given Input Source, perform the following steps:

Note: The audio signal present at the RECORD OUT Jacks is unaffected by the Stereo/Mono setting.

How to Operate the C48, con't

1. Select the desired Input Source.
2. Select "MONO/STEREO MODE, _____: Stereo" as indicated on the Front Panel Information Display. Refer to figure 63.

Figure 63

3. Set the "MONO/STEREO MODE" for either STEREO or MONO. Refer to figure 64.

Figure 64

After approximately 4 seconds the Information Display returns to indicate the Source Selection and Volume Level.

DIGITAL AUDIO DISPLAY

By default the Digital Audio Display is switched Off. To display information about the type of digital signal present when any one of the five digital inputs is selected, perform the following steps:

1. Select one of the Inputs assigned to an active digital source.

Note: The USB-D/A Input may also be selected when the C48 is connected to a computer.

2. Select "DIGITAL AUDIO, Display Info: Off" as indicated on the Front Panel Information Display. Refer to figure 65.

Figure 65

3. Set the "DIGITAL AUDIO, Display Info" to On. Refer to figure 66.

Figure 66

After approximately 4 seconds the Information Display will return to indicate the Source Selection, Volume Level and the Digital Information. Refer to figure 67.

Figure 67

PHONO ADJUSTMENTS

When the Phono MC or Phono MM Input is selected an additional TRIM SELECT FUNCTION becomes available for adjustment. Perform the following steps to make the Phono Trim Adjustments:

1. Select either the Phono MM or Phono MC Source Input.
2. Select "PHONO CARTRIDGE, Moving Coil 500 Ohm" or "PHONO CARTRIDGE, Moving Magnet 50pF" as indicated on the Front Panel Information Display. Refer to figures 68 and 69.

Figure 68

Figure 69

3. Set the desired phono cartridge loading value (Ohms for a Moving Coil Cartridge or Capacitance for a Moving Magnet Cartridge) that comes closest to the Phono Cartridge Makers recommended value.

After approximately 4 seconds the Alphanumeric Display returns to indicate the Source Selection and Volume Level.

Mono

Press the Front Panel MONO Push-button to change from Stereo to Mono Mode for the currently selected Input Source. The LED above the MONO Push-button will illuminate. Refer to figure 50. The C48 remembers for each selected Input whether the Mode is Stereo or Mono. To change the Mode from Mono to Stereo for the currently selected Input Source press the MONO Push-button.

Note: The audio signal present at the RECORD OUT Jacks is unaffected by the MONO Push-button.

Equalizer Bypass

Press the Front Panel EQ BYPASS Push-button to remove the C48 Equalizer Circuitry from the signal path for the currently selected Input Source. The LED above the EQ BYPASS Push-button will illuminate. Refer to figure 50. The C48 remembers for each selected Input whether the Equalizer Circuitry is deactivated. To re-

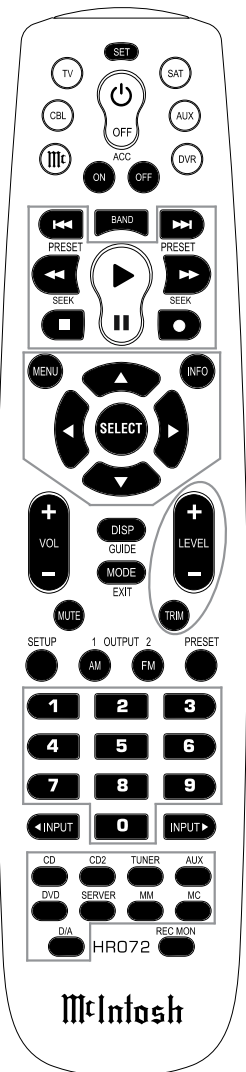

Figure 53

activate the Equalizer for the currently selected Input Source press the EQ BYPASS Push-button.

Note. The audio signal present at the RECORD OUT Jacks is unaffected by the Equalizer Circuitry.

Trim

Press the Front Panel TRIM Push-button to activate the C48 Trim Functions. Use the Front Panel OUTPUT 1 / OUTPUT 2 / ◀ MENU ▶ Push-buttons to select the desired Trim Function and then use the VOLUME/ADJUST Control to vary or make changes. Refer to figure 50. The Remote Control TRIM and LEVEL +/- Push-buttons may also be used. The LED above the TRIM Push-button will illuminate during Trim selection and adjustment. Approximately four seconds after Trim Function Selection and/or adjustments have stopped the C48 will switch off the Trim Mode.

Mute

Press the MUTE Push-button, on the C48 Front Panel or on the Remote Control, to Mute the Audio in all

outputs (Main, Output 1, Output 2 and Headphones) except the REC OUTPUT. The Front Panel Information Display will indicate the Source Name and the word MUTE in place of the actual volume setting. Refer to figure 70.



Figure 70

Pressing the Mute Push-button a second time or adjusting the volume control (either the Front Panel or Remote Control) will un-mute the C48.

Output 1 and 2

Press the Front Panel OUTPUT 1 / OUTPUT 2 Push-button or use the Remote Control and press the SETUP/BLUE Push-button followed by the OUTPUT 1 / OUTPUT 2 Push-button to send audio to separate Power Amplifiers connected to the rear panel OUTPUT 1 or 2 Jacks. It also activates the POWER CONTROL OUTPUT 1 /OUTPUT 2 Jacks on the rear panel of the C48. To stop the Audio and Power Control

Signals from going to the separate Power Amplifiers, press the same Push-button(s) a second time.

Headphones Jack

Connect a pair of dynamic headphones to the Headphones Jack with a 1/4" (0.635cm) stereo phone type plug for private listening. Press OUTPUT 1 and/or 2 Push-buttons to mute the Loudspeakers.

Note: The Headphone Output is optimized for impedances ranging from 100 to 600 ohms.

How To Make a Recording

1. Select the desired signal source you wish to record by using the Front Panel INPUT Control or the appropriate Source Push-button on the Remote Control.
2. Adjust the record level using the recorder level control and proceed with the recording process.
3. Listen to the playback of the program source just recorded by selecting the Input Source connected to the recorder component output.

Equalizer Controls

The C48 Equalizer has five Frequency Controls which will raise or lower by 12dB, the amplitude of the band of frequencies centered at the frequency marked above the controls. The center frequencies of these controls are at 30Hz, 125Hz, 500Hz, 2,000Hz and 10,000Hz. Both Left and Right Channels are affected. At the center detent or flat position of the controls, the tone circuit components are removed from the signal path.

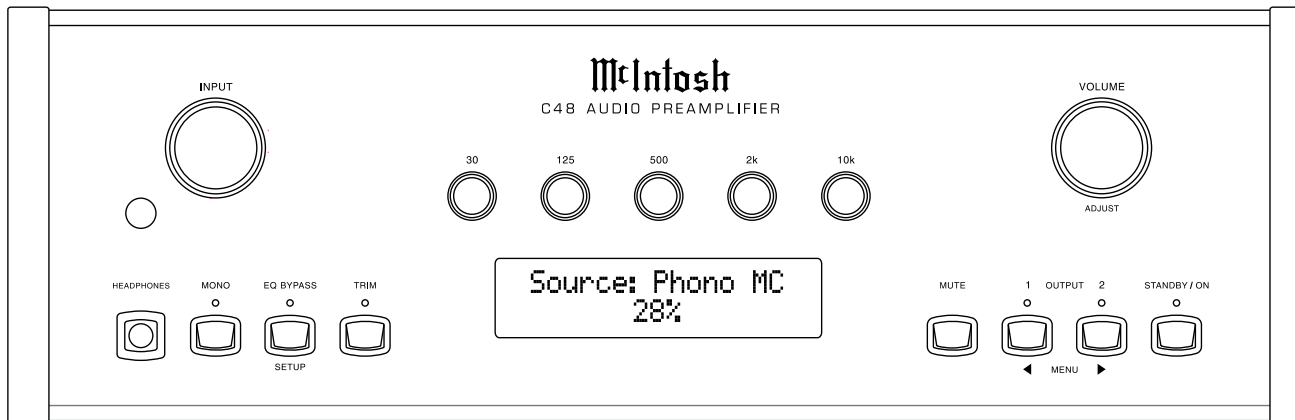

Figure 50



How to Operate the C48, con't

The illustration to the right shows the fundamental frequency range of acoustical musical instruments and the human voice. It also shows the range of adjustment of frequencies for each of the Equalizer Controls of the C48 at the +6dB and -6dB points.

Passthru

When the C48 is connected together with a McIntosh Multichannel A/V Control Center or Surround Decoder and has the PASSTHRU MODE activated, it will automatically turn-on when the A/V Control Center or Surround Decoder is turned On. It will indicate on the Front Panel Alphanumeric Display "PASSTHRU". Refer to figure 71.



Figure 71

The C48 OUTPUT 1 / OUTPUT 2 Front Panel Push-buttons are active when in the Passthru Mode. The other Front Panel Controls and Push-buttons are deactivated as long as the Passthru Mode is active

Optical and Digital Inputs

When a Digital Input (Optical or Coaxial Connection) on the C48 is selected the Front Panel Information Display will indicate when a signal is present "2CH PCM". Refer to figure 72. During the time there is no



Figure 72

Digital Signal present the display will indicate "SILENT". Refer to figure 73.

Fundamental Frequencies of Acoustical Musical Instruments and the Human Voice

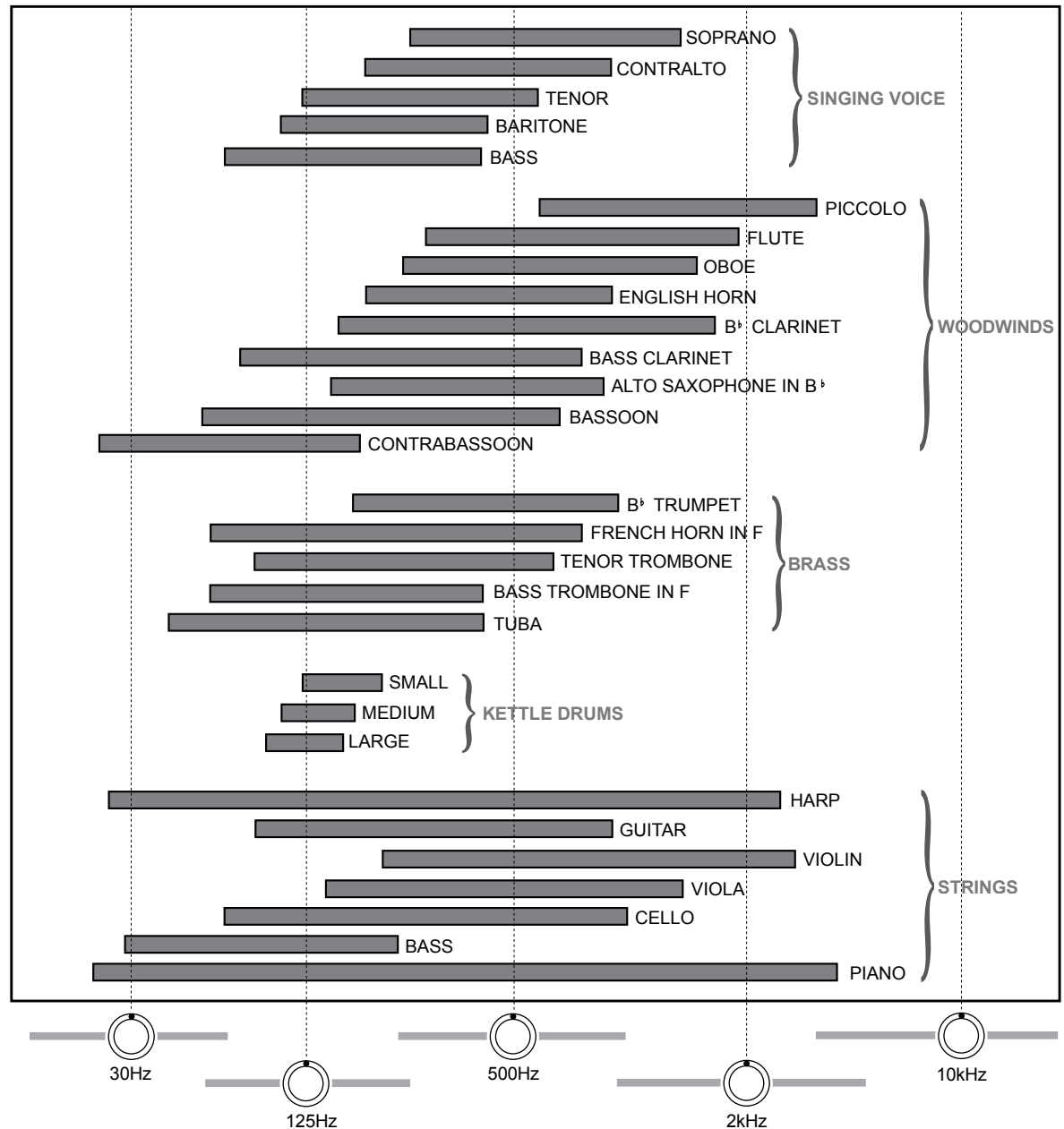



Figure 73

USB Input Operation with a Computer

The C48 USB-D/A Input provides the capability to playback music from a computer, when the computer is connected to the rear panel USB D/A connector. The C48 USB Input is compatible with both PC Computers using Microsoft® Windows® (XP with Service Pack 3, Vista with Service Pack 1 and Windows 7) and the Apple® Macintosh® Computers using OS-10.6 with the latest update.

When using a PC Computer with Windows, a special McIntosh USB Audio Software Driver needs to be installed on the PC Computer. The driver needs to be installed before connecting the C48 USB Input to an USB Port on the computer.

Note: If an Apple Macintosh computer is used with the C48, no additional driver is required.

The McIntosh USB Audio Windows Driver and Installation and Operation Guide are available for download from the McIntosh Web Site:

<http://www.mcintoshlabs.com/us/support/Pages/Manuals.aspx>

Under “Product Category” select Preamplifiers and under “Model Number” select C48, then click on “Select”. When the C48 Information appears, download the “McIntosh Audio Windows Driver Installation and Operation Guide” and “McIntosh USB Audio Windows Driver V_ . _”. Follow the instructions in the Guide

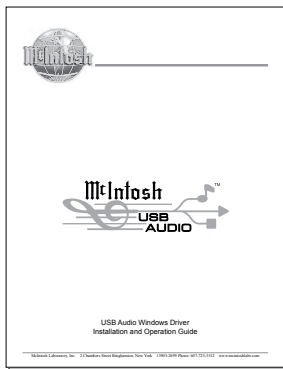

and after the USB Driver is installed, connect the C48 to the PC Computer.

When a disc in the computer is playing back, the PLAY ►, PAUSE ||, NEXT TRACK ►►, BACK TRACK ◀◀ and Stop ■ Push-buttons on the McIntosh HR072 will control playback of the disc.

Note: When computer application programs and various computer hardware components conform to the Microsoft® Windows® and Apple® Macintosh® standards they should also work well when used in conjunction with the C48 USB Input. If you are experiencing difficulty with a specific computer hardware component or computer application program, contact the manufacturer of the product.

The C48 Preamplifier Front Panel Information Display will indicate the Bit and Sampling Rate of the incoming digital signal. Refer to figure 74.



Figure 74

Reset of Microprocessors

In the unlikely event the controls of the C48 stop functioning, the microprocessors can be reset by performing the following:

1. Press and hold the STANDBY/ON Push-button for approximately ten seconds and then release.
2. To switch the C48 back on press the On STANDBY/ON Push-button.

Note: This can be performed with the C48 On or in the Standby Mode.

Resetting the C48 to default settings

If it becomes desirable to reset all the adjustable settings (Setup and Trim Settings) to the factory default values, perform the following:

1. Press both the MONO and OUTPUT 2 Push-buttons until the Front Panel Display indicates “FACTORY RESET” (refer to figure 75), then



Figure 75

release the two push-buttons. Several seconds later the Front Panel Display will indicate “FACTORY RESET, -COMPLETE-” and the C48 will switch Off. Refer to figure 76.



Figure 76

2. Press the STANDBY/ON Push-button and the C48 will resume operation.





Specifications

Frequency Response

+0, -0.5dB from 20Hz to 20,000Hz

+0, -3dB from 15Hz to 100,000Hz

Total Harmonic Distortion

0.002% from 20Hz to 20,000Hz

Rated Output (Main)

2.5V Unbalanced, 5V Balanced

Maximum Voltage Output

8V RMS Unbalanced, 16V RMS Balanced

Sensitivity (for rated output)

High Level, 450mV unbalanced, 900mV balanced

Phono MM, 4.5mV

Phono MC, 0.45mV

Signal To Noise Ratio (A-Weighted)

High Level, 100dB

Phono, 88dB

Equalizer Controls

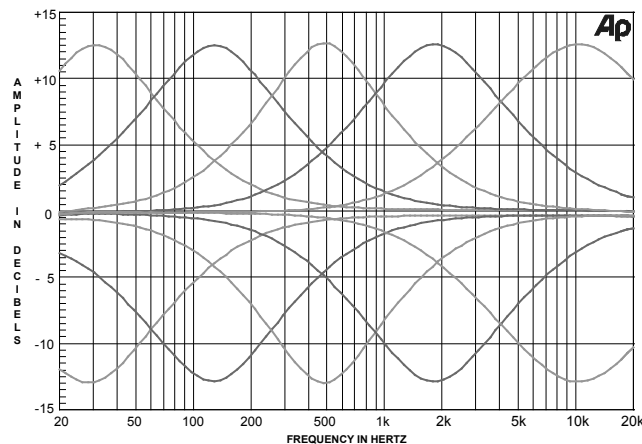

Input Impedance

High Level, 22K ohms unbalanced, 44k ohms balanced

Phono MM, 47K ohms; 50 to 750pF, in 50pF steps

Phono MC, 25, 50, 100, 200, 500 or 1,000 ohms;
100pF

Maximum Input Signal

High Level, 5V Unbalanced, 10V Balanced

Phono MM, 50mV

Phono MC, 5mV

Voltage Gain

High Level to Record Output: 0dB

High Level to Main Output: 15dB

Phono MM to Record Output: 40dB

Phono MC to Record Output: 60dB

Output Impedance

220 ohms

Headphone Load Impedance

100 ohms to 600 ohms

Digital Input Sample Rates

Optical: 16Bit, 24Bit - 32kHz to 96kHz

Coaxial: 16Bit, 24Bit - 32kHz to 96kHz

USB: 16Bit, 24Bit, 32Bit - 32kHz to 192kHz

Power Control and Trigger Output

12VDC, 25mA

Power Requirements

Field AC Voltage conversion of the C48 is not possible. The C48 is factory configured for one of the following AC Voltages:

100 Volts, 50/60Hz at 30 watts

110 Volts, 50/60Hz at 30 watts

120 Volts, 50/60Hz at 30 watts

220 Volts, 50/60Hz at 30 watts

230 Volts, 50/60Hz at 30 watts

240 Volts, 50/60Hz at 30 watts

Standby Power, less than 0.5 watts

Note: Refer to the rear panel of the C48 for the correct voltage.

Overall Dimensions

Width is 17-1/2 inches (44.45cm)

Height is 6 inches (15.24cm) including feet

Depth is 18 inches (45.72cm) including the Front Panel, Knobs and Cables

Weight

26.5 pounds (12.0 kg) net, 41 pounds (18.6 kg) in shipping carton

Shipping Carton Dimensions

Width is 27 inches (68.6cm)

Height is 12 inches (30.5cm)

Depth is 25 inches (63.5cm)

Packing Instructions

In the event it is necessary to repack the equipment for shipment, the equipment must be packed exactly as shown below. It is very important that the four plastic feet are attached to the bottom of the equipment.

This will ensure the proper equipment location on the bottom pad. Failure to do this will result in shipping damage.

Use the original shipping carton and interior parts only if they are all in good serviceable condition. If a shipping carton or any of the interior part(s) are needed, please call or write Customer Service Department of McIntosh Laboratory. Refer to page 4. Please see the Part List for the correct part numbers.

Quantity	Part Number	Description
1	033838	Shipping carton only
4	033837	End cap
1	033836	Inside carton only
1	033725	Inner carton top pad
1	034301	Bottom pad
2	034446	Foam plug
4	017937	Plastic foot
4	400159	#10-32 x 3/4" screw
4	404080	#10 Flat washer

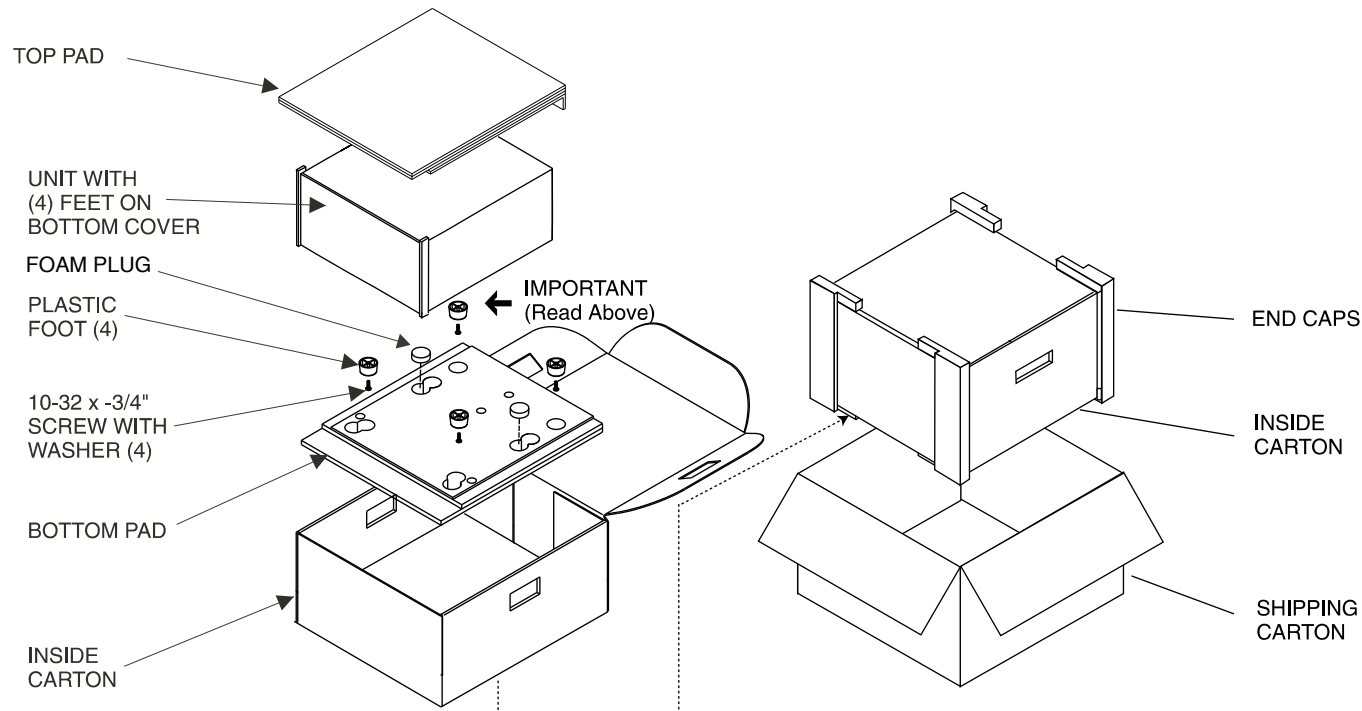



McIntosh Laboratory, Inc.
2 Chambers Street
Binghamton, NY 13903
www.mcintoshlabs.com

The continuous improvement of its products is the policy of McIntosh Laboratory Incorporated who reserve the right to improve design without notice.
Printed in the U.S.A.

McIntosh Part No. 04122802