



LINE MAGNETIC AUDIO

OWNER'S MANUAL
MODE D'EMPLOI
BEDIENUNGSANLEITUNG
MANUAL DEL USUARIO
MANUALE DI ISTRUZIONI

ENGLISH

FRANÇAIS

DEUTSCH

ESPAÑOL

ITALIANO

LM-88IA

Integrated vacuum tube amplifier - Push Pull KT88 - 2x42W (Fixed)

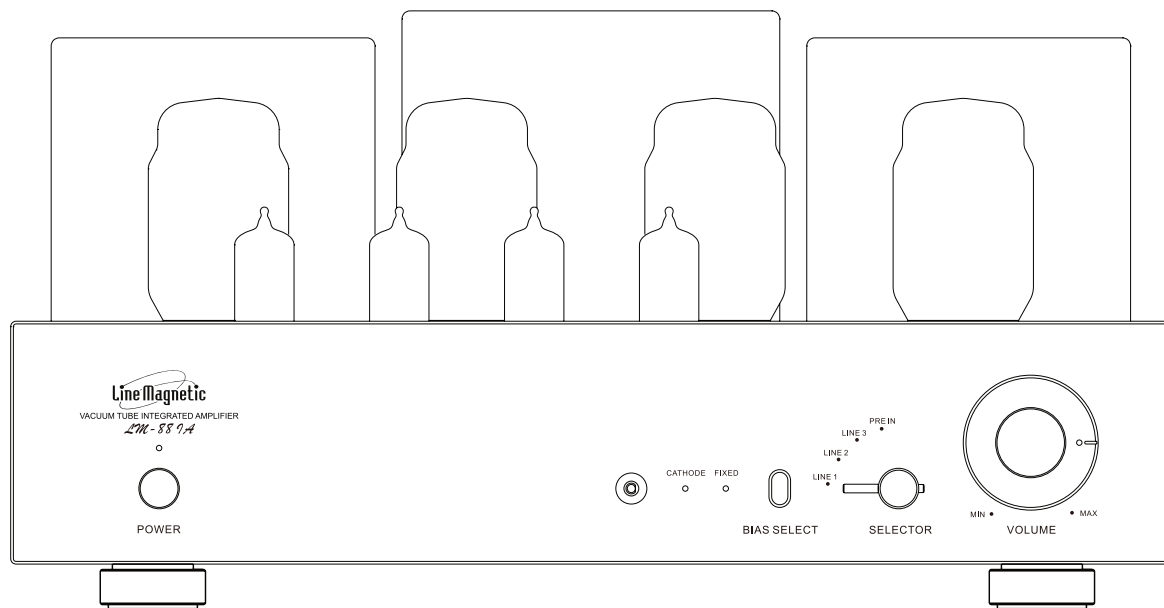

www.line-magnetic.eu

Downloaded from www.linephaze.com

- Find specs, manuals and used listings across thousands of audio products.

Thank you for choosing a Line Magnetic product. Its implementation has been our know-how, both in terms of design to the manufacturing. Electronic components and mechanical parts correspond to the selection criteria of very high quality. Operation and finish of each product have been checked before delivery. To obtain best results, please read the advice contained in this document.

Please read this manual carefully before installation and operation.

In order to prevent damage during transportation, the amplifier and its tubes are packed with protective foam, please remove these foam pieces before operating your amplifier to avoid any risks!

Table of contents

Table of contents	2
Package contents	3
Product features	3
Specifications	4
Safety instructions	4
Recommandations	4
Recycling product	5
Glossary	5
Location and precautions	5
Power sources	6
Warranty	6
Functions descriptions (front view)	7
Functions descriptions (rear view)	8
Bias adjustment (top view)	9
Speaker connection	10
Audio connection	11
Turning on	12
General observations	12
Remote control	13
Tube replacement	14
Maintenance	14
Troubleshooting	15

WARNING

Make sure that the device is not plugged into the mains before making any connections. It is also recommended to turn off or disconnect all other devices associated while making connections to the product.

Keep all packing materials for future use and please fill in the warranty card for registration of warranty. Please make sure that your local voltage is the same as indicated on the rearpanel. A too low or too high voltage can cause serious damage to your amplifier. In case you find an improper voltage, please contact our company or your local dealer.

Package content

- 1x LM-88IA
- 2x Fuses
- 1x Detachable power cord
- 1x Remote control
- 1x This user manual

Product features

Forty-two watts per channel, Class AB Integrated Stereo Amplifier with KT88 output power tubes, 6CL8A and 12BH7 input tubes. Tubes we selected for the amplifier is Electro Harmonix 12BH7, Mullard 6CL8A and JJ Electronics KT88.

- Well selected and matched tubes. No matter it is the Pre-stage or power stage of tubes we select and choose the best matching ones to use on the same unit of amplifier to get the best sound quality out of it.
- LM-88IA Amplifier can operate in two different ways Cathode bias or Fixed Bias. You can select the one you prefer. Power output for fixed mode is 42 watts while for cathode bias it is 30 watts per channel. Once worked in fixed mode it outputs a more warmth sound and go near to the way of Class A operation.
- Three pairs of Line inputs. One Pre in and speaker terminals for 4, 8 or 16 ohm speakers are located on the back panel.
- Different from other inputs Pre in offers you a possibility to connect to some other Preamplifier so that you can see LM-88IA as a power amplifier.
- RCA terminals are specially designed by Line Magnetic for the amplifier. It can reduce the signal loss during transition and guarantee the sound quality.
- Specially designed Toroid transformers made of Z11 Core for power supply and two Japanese Audio grade EI types of output transformers with wide bandwidth are applied. All transformers and chokes are encapsulated and installed separately on the amplifier to avoid and lower the disturbance between each other.
- Audio Grade of components for LM-88IA: Japanese ALPS volume potentiometer, Multicap coupling Capacitors, American MIT Coupling Capacitors, German MCAP Coupling Capacitors, etc.
- User bias control has been used for bias adjustment with Meter monitoring on top. Bias adjustment is only needed for working under Fixed Bias Mode.
- You can control the volume with the remote unit or the volume knob on the front panel. In our design in order to give you a precise idea on the volume level we are designing the volume knob at a way of Clock so you can easily judge and choose the volume level.
- Soft start and time-delay circuit. (30 seconds).
- Metal and removable tube guard cage
- Infrared Remote control

Specifications

Power output: Fixed mode: 42W + 42W Cathode mode: 30W + 30W	Working conditions: Temperature: 0°C to 40°C Moisture: 20% to 80%
Frequency response ($\pm 1,5$ dB): 20Hz-50KHz	Storage conditions: Temperature: -20°C to 70°C Moisture: 20% to 90%
Input sensitivity: Line: 180mV Pre-in: 1000mV	THD: 1% S/N ratio: 87dB
Dimensions (W x H x D) : 436 x 220 x 366 mm	Input impedance: 100k Ω Output impedance: 4 Ω , 8 Ω , 16 Ω
Tubes: 2 x 6CL8A, 2 x 12BH7, 4 x KT88	Net weight: 30kg
Power requirements: 230V $\pm 5\%$ (50Hz)	Power consumption: 250W

Safety instructions

We invite you to read the instructions on the proper use of your product carefully. They will ensure the proper functioning of the latter and it safely.

- Do not use this device in a wet area, near water, do not expose to rain or moisture.
- Do not place any objects filled with liquids such as vases or some others on the top or around.
- Do not move the product if it has just been used or if it is still hot.
- Do not install near heat sources. To avoid being overheated please keep the unit's ventilation open.
- Never cover the ventilation of the unit.
- Amplifier should install steadily and make sure all four feet are on the same level.
- Keep the amplifier in 15 cm's distance to the surrounding walls.
- Temperature will become higher after working in long period of time and please keep the unit's ventilation open and install the amplifier at a well-ventilated place to avoid troubles and fire hazard.
- Clean only with a dry cloth. As a precaution, it is best to unplug the unit before handling and ensure the heat generated by the product has been properly dissipated.

- Please move the amplifier carefully not to drop the unit or be subject to other strong shocks.
- Unplug the power cord if you are not going to use the product for an extended period of time or during lightning storms.
- Take great care of electrical connections (power cord and plugs). In particular, do not walk on, or press the power cord, specifically at plugs, power plant and the output of the power supply.
- Be sure to use an appropriate power supply to the power jack on the unit outlet. Especially if the device is equipped with a ground plug, it is necessary to use it.

- Forbidden to operate as unloaded.
- Forbidden to operate when the output is open or shorted.
- Do not attempt to service this product yourself. Opening the cover may expose you to dangerous voltage or other hazards.
- Use only spare parts and accessories recommended by Line Magnetic.

- We are not responsible for any problems caused by checking and opening without permission of our company. For service, please contact a local dealer or qualified service technician.

Recommendations

Input voltage level of the amplifier is 230VAC $\pm 5\%$ and please make sure that your local voltage is the same as indicated on the rear panel. A too low or too high voltage can cause serious damage to your amplifier. In case you find an improper voltage, please contact our company or your local dealer.

With headphones, do not use it to excessive noise. Otherwise, prolonged listening at high volume levels may cause permanent damage to your hearing.

When disposing of used batteries, please comply with governmental regulations or rules defined by the public statements relating to the environment applicable in your country.

Never expose the batteries (battery pack or batteries installed) to excessive heat such as sunshine, fire, etc ...

Recycling product

At the end of its useful life, this product should not be disposed of with regular garbage, but returned to a collection point for the recycling of electrical and electronic components. This point is emphasized by the symbol on the product, the instruction manual and on the packaging.

The materials can be reused in accordance with their markings. Through reuse and recycling of raw materials or any other form of recycling, you make an important contribution to environmental protection. Your municipality can tell you where is the point of the nearest collection site.

Glossary



This symbol alerts the user to the presence of «dangerous voltage» uninsulated which may pose a risk of electric shock to the user.



This symbol alerts the user that the documentation that comes with the device contains important instructions for maintenance and proper use of the product.



The CE mark indicates that this product complies with European directives called «low voltage» (2006/95/EC), Electromagnetic Compatibility (2004/108/EC) and apply eco-design requirements for energy products (2009/125/EC) when the appliance is installed and used in accordance with the user manual.

For continued compliance only Line Magnetic accessories must be used with this product and servicing must be performed by specialized and qualified staff.



The WEEE symbol is that of the European Union regarding the recycling of electrical and electronic equipment. It indicates that this product contains electrical and electronic components that can be reused, recycled or recovered. Therefore this product should not be disposed of in your regular trash. Thank you to return the unit or contact your authorized dealer for more information.

Location and precautions

Avoid placing it in direct sunlight or near a heat source. No source of light shall be placed on the apparatus. Also avoid all sources that could cause vibration, dust, cold or moisture. The recommended ambient temperature range is 5-35 °C.

The device must be installed on a stable, level surface. Do not place the unit on an unstable surface or shelf. The unit may fall, causing serious injury to a child or adult as well as serious damage to the product. Do not place other equipment on top of the unit.

Due to stray, turntables or CRT TVs magnetic fields should not be located near the unit to avoid possible interference.

Power sources

The unit should be operated only from the type of power source indicated on the label. If you are unsure of the type of power available to you, thank you to contact your dealer or the company responsible for the power supply in your area.

Turn off device if you do not intend to use this unit for a long time.

In case of prolonged absence from home, it is recommended to unplug from the electrical outlet.

Make sure each cable is correctly inserted. To prevent hum or background noise, do not mix different other antenna cable with the power cord or speaker wires.

Warranty

Keep all packing materials for future use and please fill in the warranty card for registration of warranty.

Your Line Magnetic product is covered by the legal warranty in force in your country. You may also have other rights which vary from country to country, state to state.

The guarantee of the product is linked to the exclusive use of tubes supplied by the official distributor and in accordance with the assembly technical specifications.

In addition, you benefit from a commercial guarantee offered by BC Diffusion on the products Line Magnetic.

For details on this warranty, please refer to the information available on www.line-magnetic.eu.

Functions descriptions

Input voltage level of the amplifier is 230VAC \pm 5% and please, make sure that your local voltage is the same as indicated on the rear panel. A too low or too high voltage can cause serious damage to your amplifier. In case you find an improper voltage, please contact our company responsible for the power supply or your local dealer.

Front panel

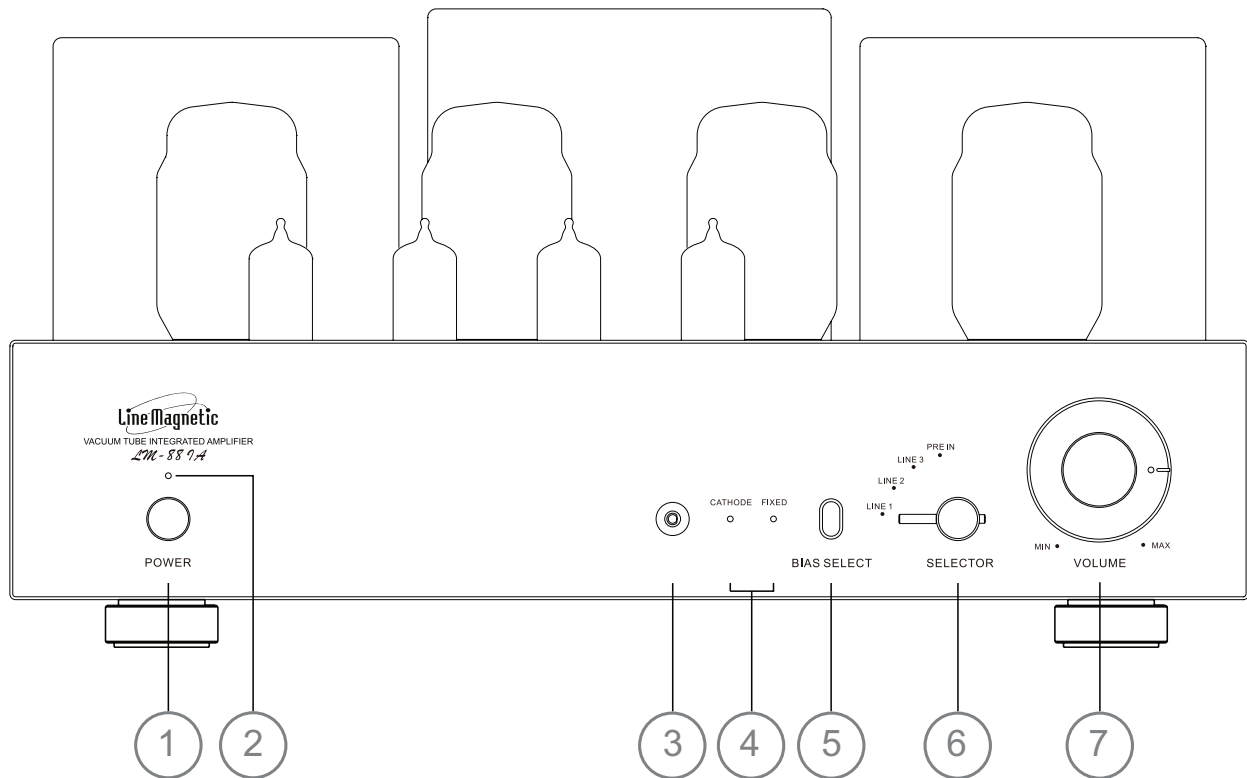

- ① Power: ON/OFF. Turn on or turn off the amplifier.
- ② Operation/Mute: Indicate the state of the amplifier. Orange means operation and if turning on it will twinkle for 30 seconds during the time delay. If it is muted the indicator will twinkle too. (Mute from remote control).
- ③ IR remote sensor: React according to the orders of the remote. It is essential that there are no obstacles between the remote control and the sensor.
- ④ Indicators for Fixed bias and Cathode bias.
- ⑤ Selector between Cathode bias and fixed bias.
- ⑥ Selector: Source selection among LINE 1, LINE 2 and LINE 3 inputs.
- ⑦ Volume knob: This volume knob adjusts the output volume of the amplifier sent to the loudspeaker. Volume up to the right while volume down to the left.

Rear panel

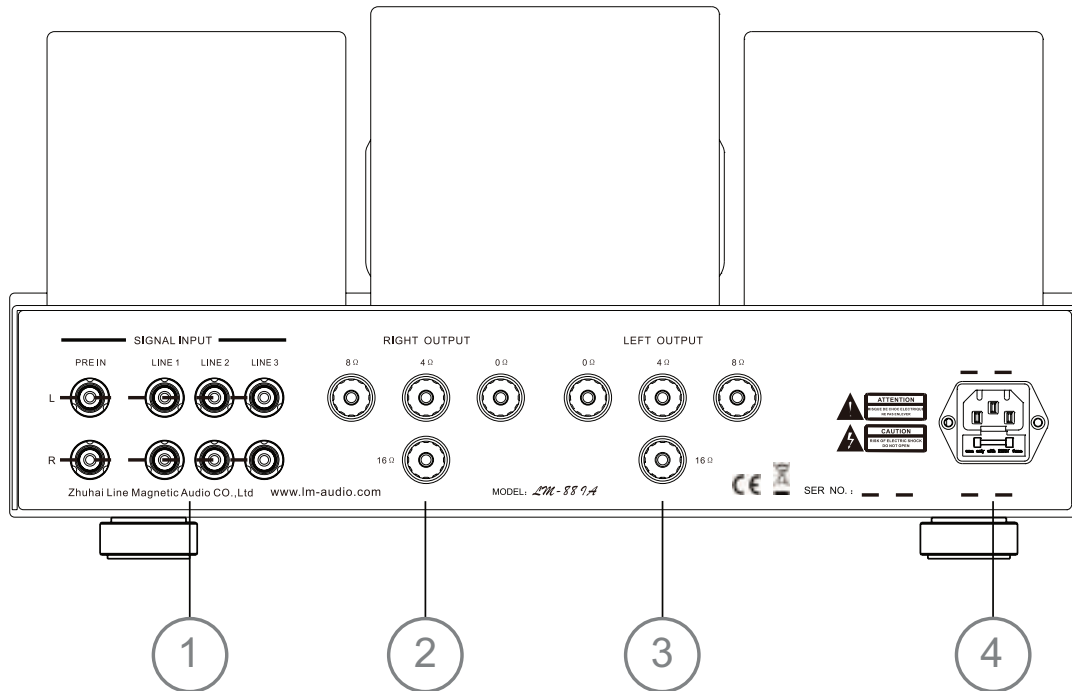

- ① Signal input: Inputs (RCA plugs) are for connecting a «line level» source to your amplifier. It is designed to receive an «analog» signal (as opposed to «digital» signal). To connect your source we are using a traditional «RCA» cable, they are usually identified by a color code «RED» to the RIGHT channel and «WHITE» to the LEFT channel.
- ② Right output: Connect the speaker to the terminals marked RIGHT «+ R» and «R -» ensuring that «R +» is connected to the «+» terminal of the enclosure and «R -» is connected to the terminal «-» the same enclosure.
- ③ Left output: Connect the LEFT speaker to the terminals marked «L +» and «L -» by doing the same.
Important Note: Check the impedance of your speakers. When using a pair of speakers, you can use speakers with an impedance of between 4, 8 and 16 ohms. BE SURE TO USE THE MATCHING TERMINALS.
- ④ Power Socket with main fuse: Main fuse is located on the rear of the amplifier just below the power cord socket. Replace with the same type and value fuse.
Once all connections to the amplifier have been made, connect the power cable to an electrical outlet and turn on the unit as it is ready for operation.

Top view

V1 to V4:
KT88 tubes

V5 and V8:
12BH7 tubes

V6 and V7:
6CL7 tube

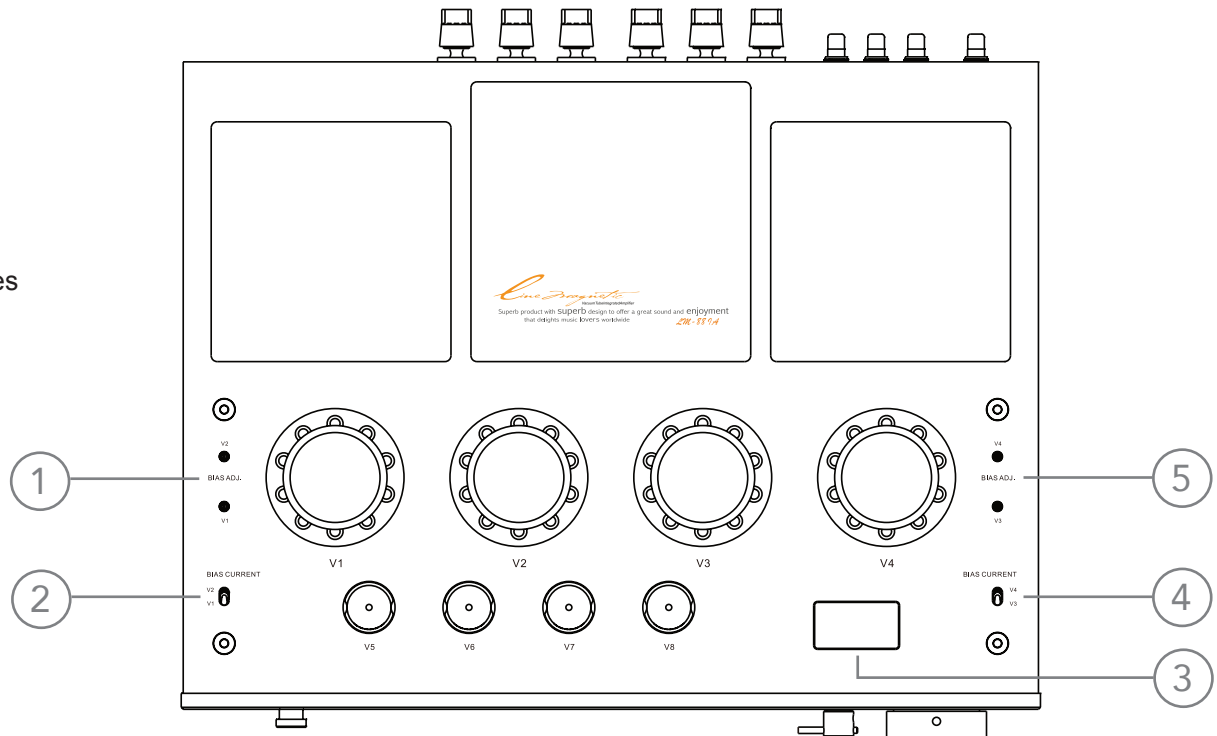

- ① BIAS ADJ.: Bias adjustment screws for tubes V1 and V2.
- ② BIAS CURRENT: Allows to view the tube V1 bias level on the ampere meter when the small handle is down and when the handle is up, you can see the bias level on the ampere meter for the V2 tube.
- ③ Ampere meter: Monitor the currency of the power tubes.
- ④ BIAS ADJ.: Bias adjustment screws for tubes V3 and V4.
- ⑤ BIAS CURRENT: Allows to view the tube V3 bias level on the ampere meter when the small handle is down and when the handle is up, you can see the bias level on the ampere meter for the V4 tube.

Bias adjustment for KT88 tubes

Note: You do not need to perform the bias adjustment when using the amplifier for the first time. Turn on the amplifier and wait for about ten minutes.

WARNING : When making adjustments, be careful not to burn yourself with tubes that are very hot.

Select the tube you want to adjust (from V1 to V4), then position the Bias Current and adjust the tube bias with a small screwdriver. Make sure all the bias level of V1, V2, V3 and V4 are the same.

Inspect the ampere meter on the front panel and make sure the needle is in the area $i_a=40\text{mA}$ shown on this diagram (right side).

The current adjustment must be the same for the 4 tubes in order to obtain an optimal sound reproduction of the amplifier.

If you have any questions, please contact a local maintenance service or your local dealer.

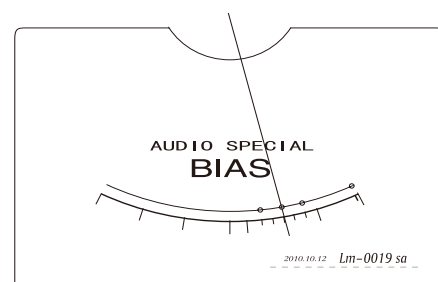

Speaker connection

WARNING: Make sure that the device is not plugged into the mains before making any connections. It is also recommended to turn off or disconnect all other devices associated while making connections to the product.

Never operate the amplifier without having first connect the loudspeakers. The principle of operation amplifier tube is different from transistor amplifier; without «charges» energy amplifier is dissipated in transformers out what is harmful for the durability of the product.

Check the impedance of your speakers. When using a pair of speakers, you can use speakers with an impedance of between 4, 8 and 16 ohms. **BE SURE TO USE THE MATCHING TERMINALS.**

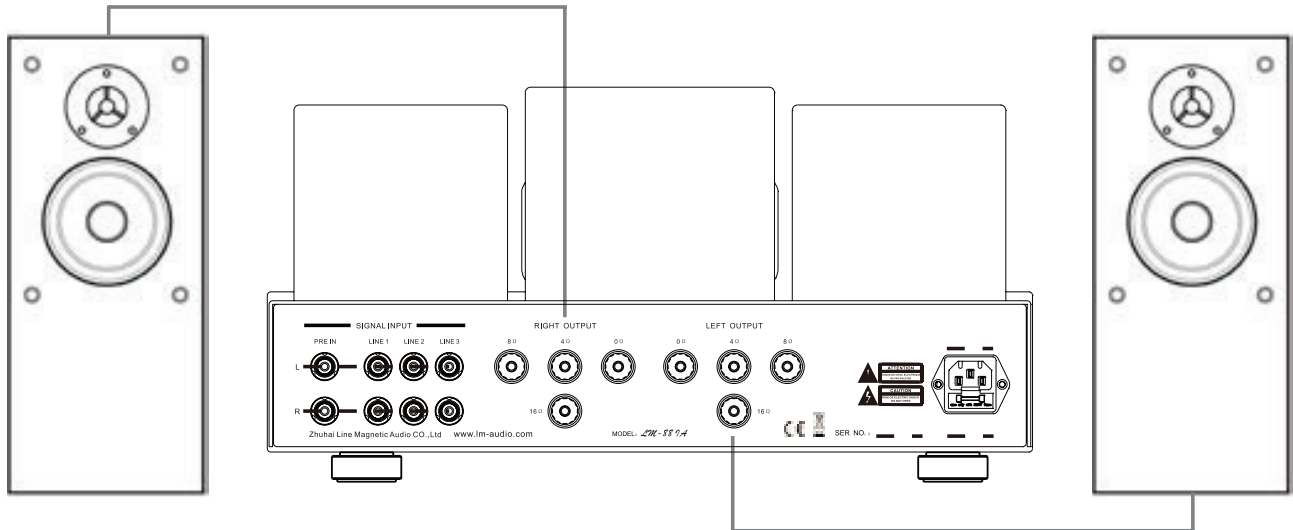

Connect your speakers to the amplifier

- 1- Unscrew the terminal by hand.
- 2- Insert the loudspeaker cable (refer to the diagram below).
- 3- Screw the terminal.
- 4- Repeat the same operation for the other 3 terminals.

Connect the speaker cables with the amplifier after it is well connected with the speakers.

Please notice the right direction indication of the cable and do not mix up the positive and the negative end.

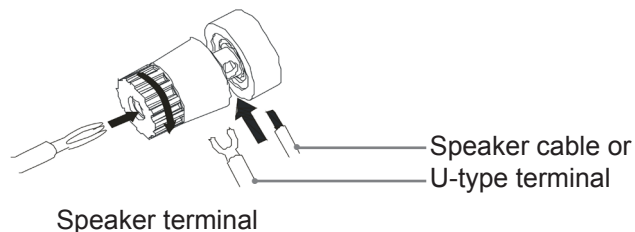

Make sure that no wires are not insulated can bypass the speaker outputs. Make sure that the speaker terminals are tight enough to ensure a good electrical connection. If the terminal screws are not tight enough, the sound quality may be affected.

Use only dedicated wire to the speaker (a section of 1.5 mm² or more is recommended especially if the cable length is greater than 3m).

Audio connection

Connect other audio equipment to your amplifier

Use a RCA (Cinch) stereo audio cable (red and white plugs) to connect your sources.

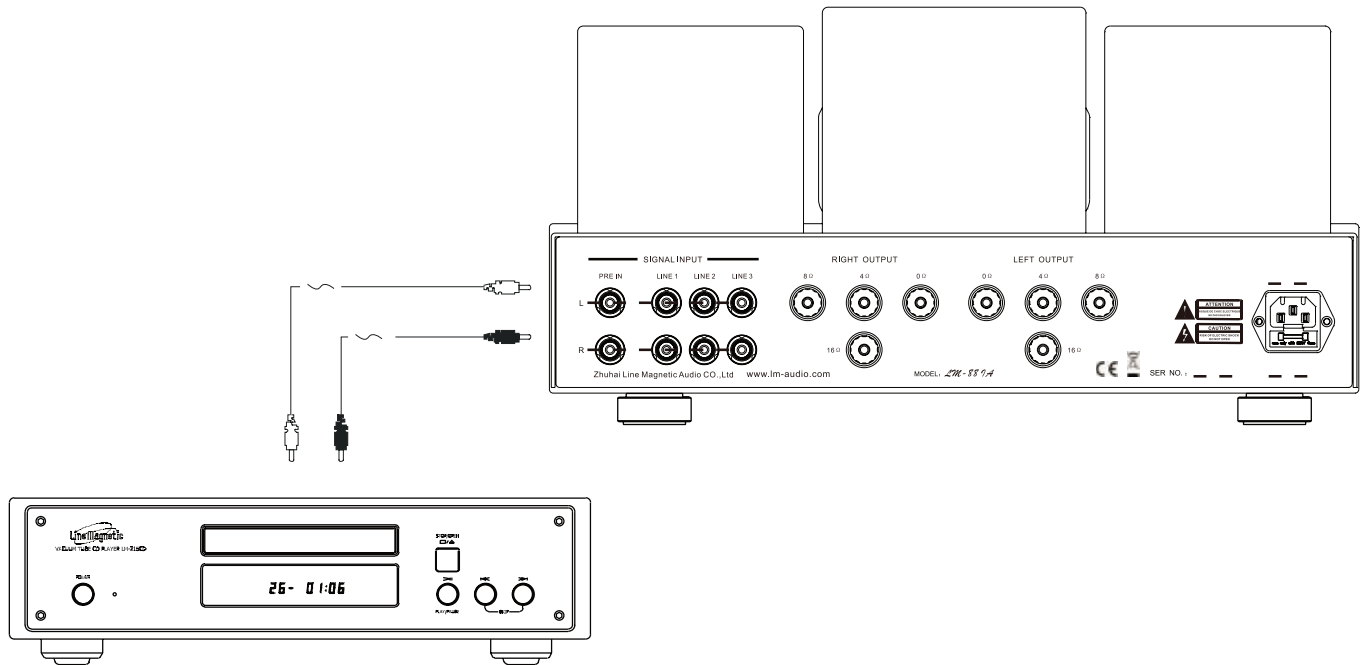

- 1- During installation please always refer to other product's operation manuals.
- 2- Please do not insert the power cord into the main socket only if all other sources are well connected.
- 3- «R» refers to the Right channel while «L» represents the Left channel.
- 4- Please take the right guidance for connection as wrong connection may cause noise or low grade function. Do not also fasten signal cables together with other cables just like the power cables to avoid disturbance.

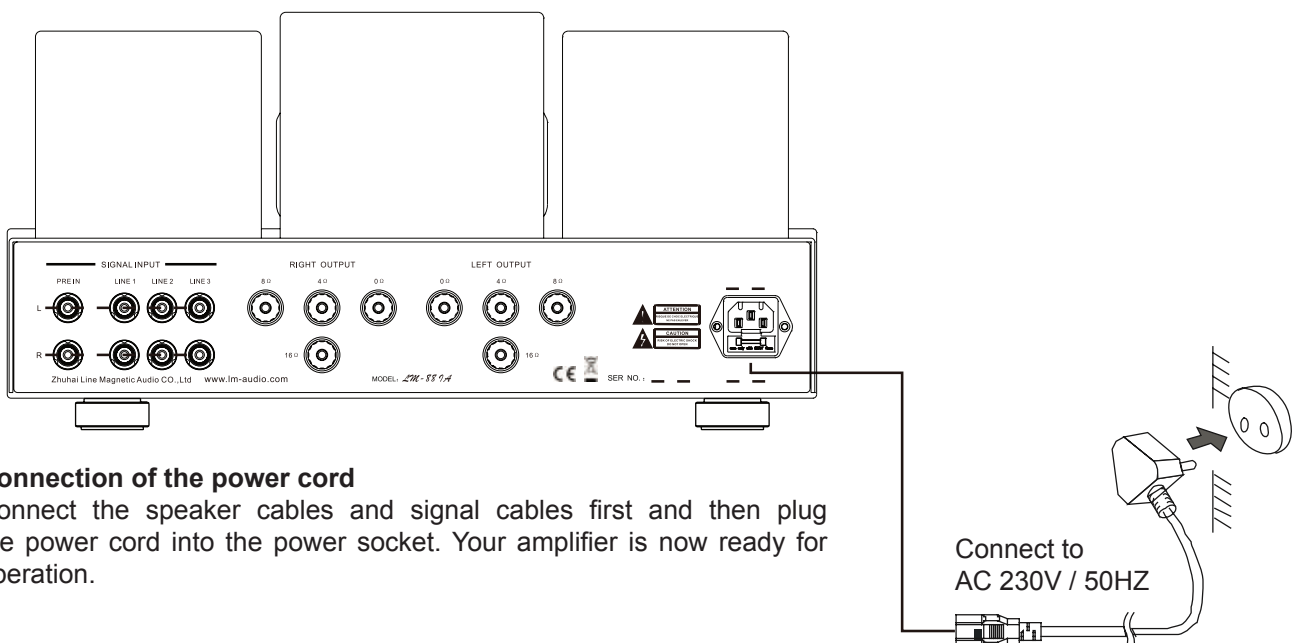

Connection of the power cord

Connect the speaker cables and signal cables first and then plug the power cord into the power socket. Your amplifier is now ready for operation.

Turning on

IMPORTANT - BEFORE TURNING ON THE AMPLIFIER

Make sure all connections (first, connect the speaker cables, then the cables from your sources, and plug the power cable into the AC outlet) are valid, and the stability of your power supply AC 230V - 50Hz.

Please make sure corresponding voltage is the same as required. We are not responsible for damage caused by misuse of unsuitable voltage.

Startup procedure

- 1- Set the VOLUME of the amplifier to zero (potentiometer totally on the left).
- 2- Switch the amplifier to ON position via the POWER switch located on the side of the amplifier. The LED lights up in orange on the front panel of the amplifier. It indicates that the amplifier is working.
- 3- After 30 seconds, the orange led blinking will stabilize to indicate that the amplifier is ready for use.
- 4- Select the source you want to listen to with the SELECTOR button located to the right of the front panel.
- 5- Adjust the VOLUME knob as you like to enjoy your music.

General observations

- It is normal that power transformer becomes hot for extended period of operation.
- Unplug the product during lightning storms or when not in use for a long time.
- To prevent damage to the amplifier never disconnect the speaker cables while the unit is ON.
- In order to protect the tubes please re-switch on the amplifier after turned off in two minutes.
- This product is designed and manufactured with our original parts for reaching the best results. We are not responsible for problems and damages caused to the amplifier by non-original replacement parts.
- Line Magnetic Audio reserves the right to change specifications at any time without further notice in advance if products are upgraded. Specifications on the manual only show the specifications of the amplifier you've bought.

WARNING : Please make sure corresponding voltage is the same as required. We are not responsible for damage caused by misuse of unsuitable voltage.

Remote control

The amplifier comes with LM-02 remote control.

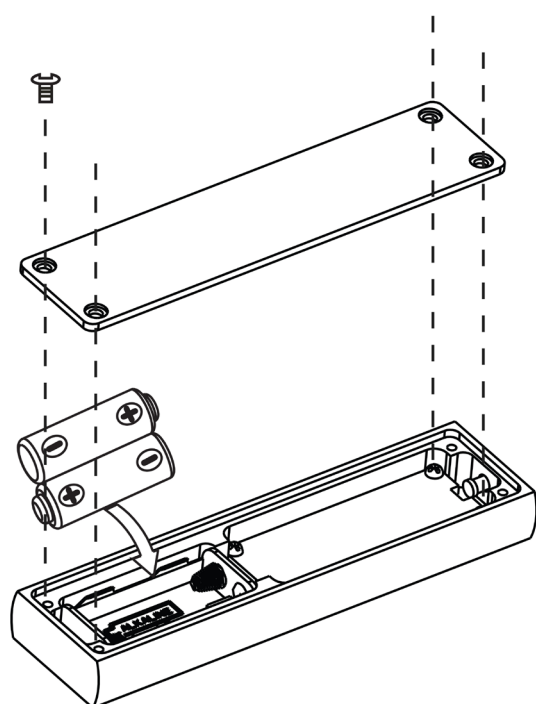
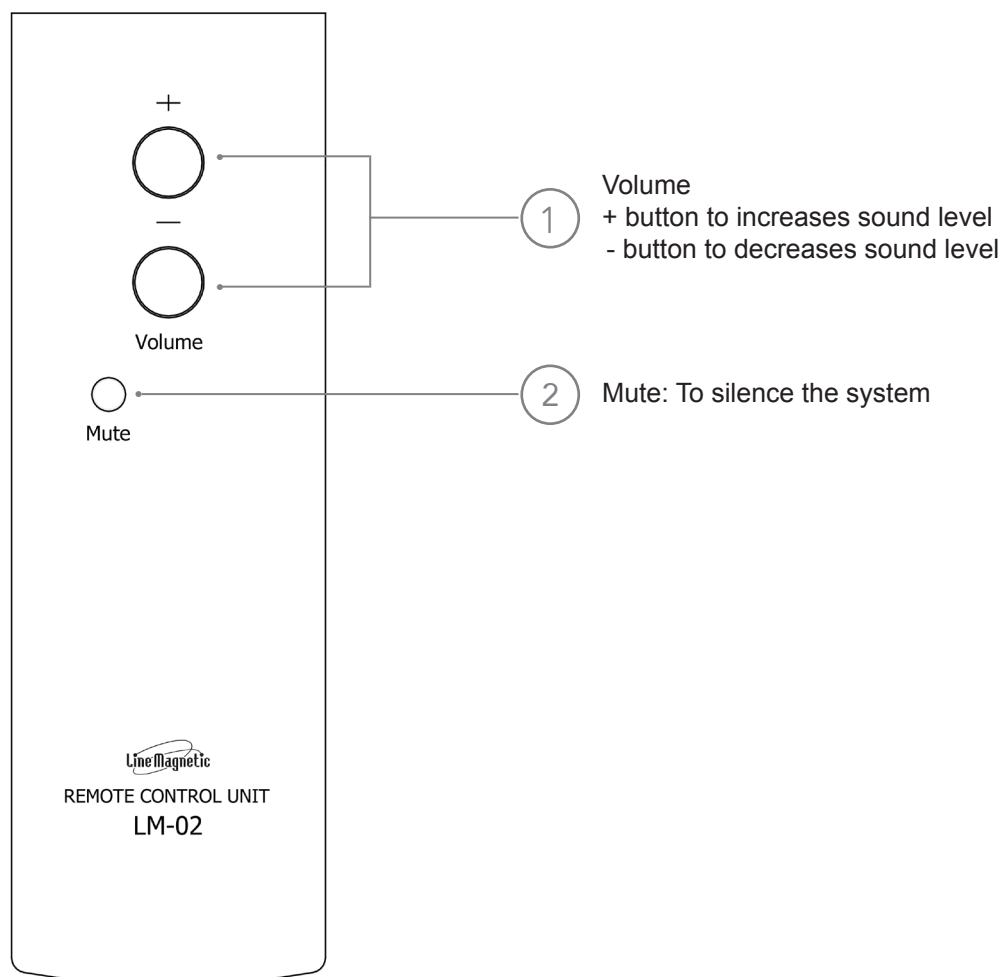

Installation and replacement of the batteries

Installation

1. Remove the screws of the remotes back cover.
2. Insert two 1,5V AAA batteries using the + and - indicators to insert them in the correct position.
3. Screw the batterie cover back into place.

Replacement of the batteries

- When the batteries are low, please replace them with new ones.
- Do not mix the new batteries with old ones.
- Please use high quality batteries, these can prevent leakage of electrolyte.

Tube replacement

Basics tubes	Common replacements
6CL7	12AX7EH, ECC83, E83CC, CV4004, ECC803, 5751
12BH7	12AU7EH
KT88	KT88EH, 6550EH, 6550, 6550A

Maintenance

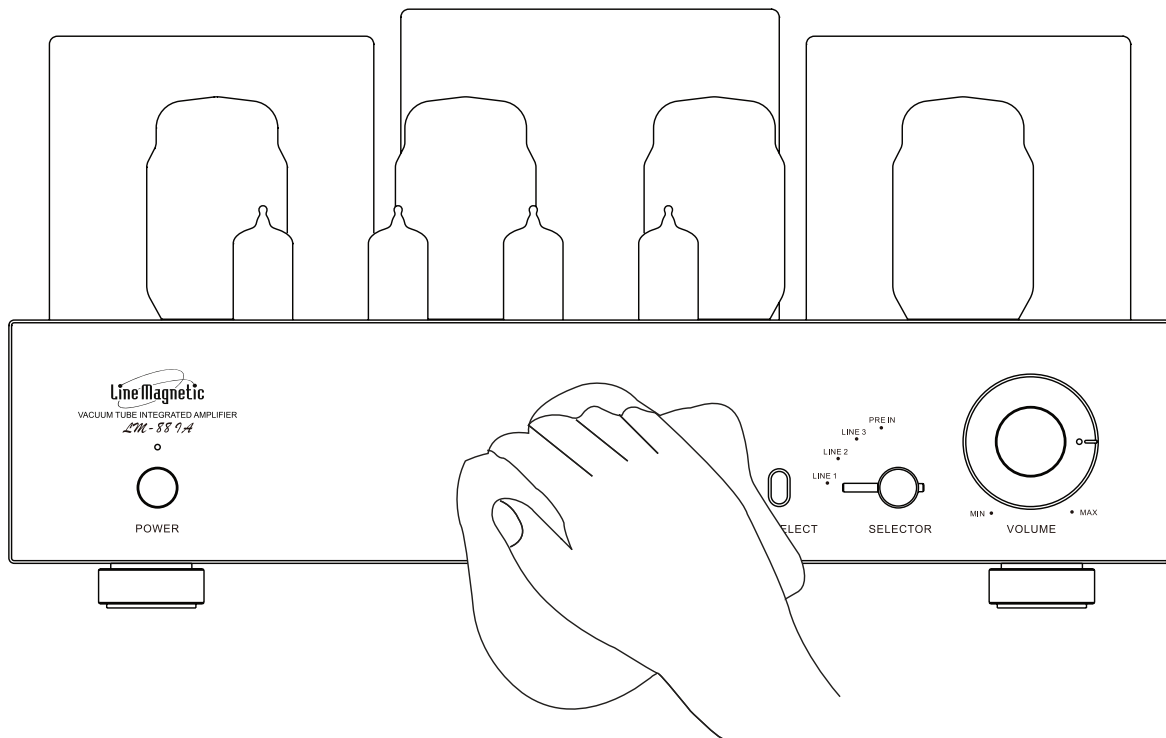

WARNING

As a precaution, it is best to unplug the unit before handling and ensure the heat generated by the product has been properly dissipated.

Cleaning

1. Use soft dry cloth to clean the amplifier.
2. Refer to the safety precautions if you are going to use chemically treated cloth for cleaning.
3. Use a soft cloth with neutral detergent first and then wipe with a dry cloth.

Troubleshooting

Please follow the instructions in this manual to keep the amplifier working in a reliable and safe manner. Sometimes problems could be caused by other related equipment, please check the connections.

If you experience a problem with this unit, please check the following items before requesting service. If it still does not operate correctly, contact the retailer where you purchased the unit.

For repair, during or after the warranty, please contact your local dealer.

Problem	Cause	Solution
Power LED is OFF.	Power cord is not well-connected.	Please check the power cable connection or power outlet connection.
	Main fuse is out.	Replace with the same type and value fuse.
	Troubles of inner parts or components.	Please contact your local dealer.
Power LED is ON.	Volume is at zero.	Turn up the Volume.
	No signal input.	Check the function of the sound source.
		Check the input connectors and/or switch to the proper input
Sound distortion.	High input signal level.	Turn down the volume to suitable position.
		Replace the signal input cable.
Noise output.	Ground of input signal cable is open or bad contact of the input signal cable.	Replace the input signal cable with a new one.
	Components or circuits are in trouble.	Please contact your local dealer.
Stereo image is not so good.	Signal input cables or speaker cables are wrongly connected.	Reconnect it as suggested in the manual.
No reaction to the remote control.	Disturbed by external devices.	Keep away from the disturbance (ie: microwave oven) and restart the amplifier.
	Batteries of the remote control are low.	Please replace the batteries.
	Obstacle is located between the remote control and the amplifier.	Move the object that blocks the IR rays between the remote control and the IR sensor located on the front of the amplifier.

The LM-881A has been designed and manufactured with parts that we manufacture to achieve an optimal result. We disclaim liability for potential problems or damage to the amplifier in the event of replacement of any of these original parts.

We are not responsible for any problems caused by checking and opening without permission of our company. For service, please contact a qualified service technician.

The logo for Line Magnetic features the brand name in a bold, black, sans-serif font. The word "Line" is positioned to the left of "Magnetic". A thin, black, hand-drawn style line loops around the top and bottom of the word "Magnetic", starting from the top left of the 'M', curving over the top, and then curving under the bottom before ending at the top right of the 'c'.

Line Magnetic

LINE MAGNETIC AUDIO

www.line-magnetic.eu

Downloaded from www.linephaze.com

- Find specs, manuals and used listings across thousands of audio products.