

DENON[®]

DENON HOME 350

WIRELESS SPEAKER

Owner's Manual

Introduction	5	Using your speaker	17
Before your begin	6	Selecting a room/speaker	17
System requirements	6	Quick Select function	18
Network requirements	6	Listening to radio	19
Getting to know your speaker	7	Playing music stored on your mobile device	19
Front panel	8	Playing music from your networked PC or NAS	20
Top panel	9	Playing music from the AUX input	21
Rear panel	10	Playing music from a USB memory device	22
Bottom panel	11	Playing music from Bluetooth device	23
Placing your speaker	12	Pairing the speaker with your Bluetooth devices	23
Wall or ceiling mounting	12	HEOS account	24
Powering your speaker	13	What is a HEOS account?	24
Getting the HEOS app	14	Why do I need a HEOS account?	24
Setting up your first speaker	15	Signing up for a HEOS account	24
Adding more speakers	16	Changing your HEOS account	24
Adding wired speakers	16	Playing from streaming music services	25
Adding wireless speakers	16	Adding a music service	25
		Changing music service settings	25
		Managing inputs	26
		Changing the name of the inputs	26
		Hiding an input	26
		Managing your phone	27

Listening to the same music in multiple rooms	28
Grouping rooms	28
Ungrouping rooms	29
Grouping all rooms (party mode)	30
Ungrouping all rooms	31
Stereo pairing	32
Creating a stereo pair	32
Changing the name of a stereo pair	34
Adjusting the balance	34
Swapping left and right channels in a stereo pair	35
Removing a stereo pair	35
Using the now playing queue	36
Play Now	36
Play Now & Replace Queue	36
Play Next	36
Add to End of Queue	36
Rearranging the now playing queue	37
Deleting songs from the play queue	37
Deleting all songs from the play queue	38
Saving playlists	38
Performing repeat and shuffle playback	38
Using the favorite	39
Adding to HEOS favorite	39
Deleting station from the HEOS favorite	39

AirPlay function	40
Playing songs from your iPhone, iPod touch or iPad	41
Playing iTunes music with your speaker	41
Play a song from your iPhone, iPod touch or iPad on multiple synced devices (AirPlay 2)	42
Making speaker adjustments	43
Changing the name of a speaker	43
Changing the wireless network connection	43
Changing the speaker's equalizer	44
Adjusting the audio quality	44
Adjusting the status light brightness	44
Advanced speaker settings	45
Network settings	45
About wireless power saving	45
Firmware upgrade	46
About	46

Updating your system	47	Status LED table	56
Advanced features	48	Supported file types and codecs	60
Sharing music from your mobile device	48	Specifications	61
Wireless performance	48	Information	63
Submit diagnostics	49	Trademarks	63
Resetting your controller app	49	License	65
Power management	50	License information for the software used in the unit	65
Power modes	50		
Quick Start Mode	50		
Deep Standby	50		
Off	50		
Basic troubleshooting	51		
Cannot connect the speaker to the network	51		
Cannot pair a Bluetooth mobile device with the speaker	51		
Cannot hear Bluetooth music	52		
Music cuts out or delays sometimes	52		
I hear a delay when using the AUX input with my TV	53		
Connecting to a network using an iOS device	53		
I hear distortion when using the AUX input	54		
Connecting to a WPS network	54		
Resetting your speaker	55		
Buttons do not operate correctly	55		

Thank you for purchasing this Denon product. To ensure proper operation, please read this owner's manual carefully before using the product.

NOTE

- This document contains information that is subject to change without notice.

Introduction

The speaker is part of the HEOS system that enables you to enjoy your favorite music anywhere and everywhere around your home. By utilizing your existing home network and the HEOS app on your iOS or Android™ device, you can explore, browse, and play music from your own music library or from many online streaming music services.

- True multi-room audio - play different songs in different rooms or the same song in every room
- Utilizes your existing home wireless network for quick and easy setup
- Industry leading microsecond audio synchronization between speaker
- Legendary Denon audio quality
- If you are in a hurry, you can be enjoying great sounding music in no time by following the steps outlined in the Quick Start Guide (packaged with your speaker).



Please continue reading this Owner's Manual for more detailed information about the features and benefits of your speaker.

Downloaded from www.linephaze.com

- Find specs, manuals and used listings across thousands of audio products.

Before your begin

NOTE

- If you have already installed at least one speaker, please skip to the section “Adding more speakers” (🔍 p. 16).

System requirements

Before you begin installing your first speaker, please make sure you understand and meet a few basic requirements.

■ Network requirements

Wireless Router - In order to use your HEOS system, you must have a working wireless (Wi-Fi) or ethernet network in your home. Even when connected to an Ethernet network, a Wi-Fi connection to the router is required to control the system using the HEOS app. If you do not have a wireless network, please contact your local Denon dealer or electronics retailer to assist you with purchasing and installing a wireless network in your home.

High Speed Internet Connection - HEOS system accesses the Internet to stream music to your home from many popular online music services. HEOS system is also designed to provide you with software updates, which are delivered via your home Internet connection. DSL, Cable, and Fiber services will provide the best experience and reliability. You may experience performance issues with slower Internet connections like satellite based services.

Getting to know your speaker

Unpack your speaker from the box and verify that the following items are included:

① Speaker

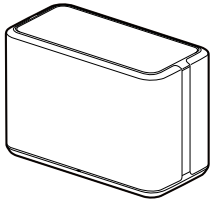

② Quick Start Guide



③ Safety Instructions



④ Notes on Radio



⑤ Warranty
(North America model only)



⑥ Power cord
(for Europe model)



⑦ Power cord
(for North America model)

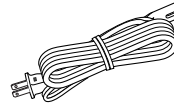

⑧ Mounting screw



NOTE

- Please use the power cord included in the box for your device.

■ Front panel

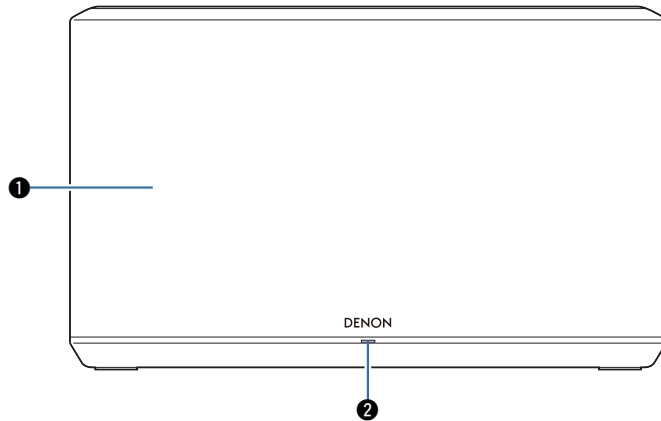

① Speakers

② Status LED

Please refer to the “Status LED table” for LED color and state meaning. (☞ p. 56)

■ Top panel

Hold your hand over the top of the speaker to show the operation panel buttons. Touch these buttons to perform operations. Moving your hand away from the area hides the buttons.

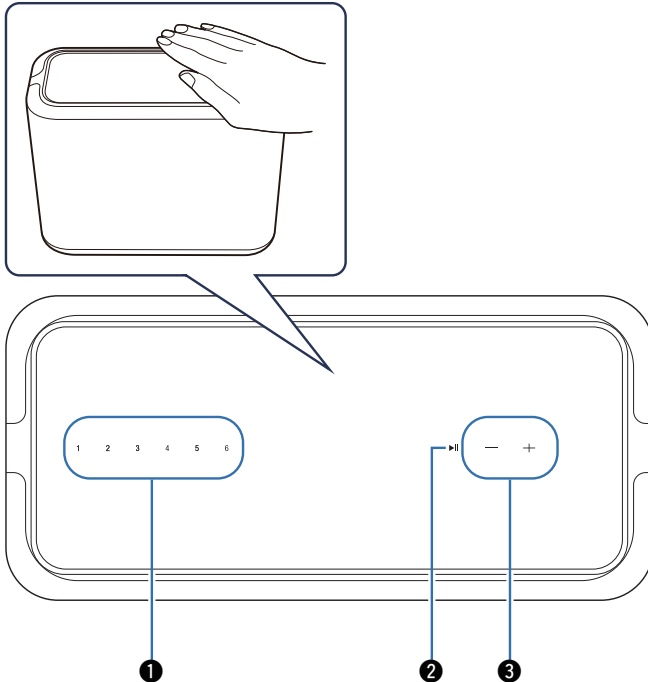

① Quick select buttons (1 - 6)

Register input source settings to these buttons or recall those settings. (👉 p. 18)

② Play/pause button (▶||)

- Press this button to pause during playback. If pressed while paused or stopped, resumes playback from the last track played.
- Press and hold the button for 5 seconds to enter Deep Standby mode. (👉 p. 50)

③ Volume buttons (+, -)

These adjusts the volume level.

NOTE

- Do not put anything on top of the speaker. Doing so may lead accidental operations.

■ Rear panel

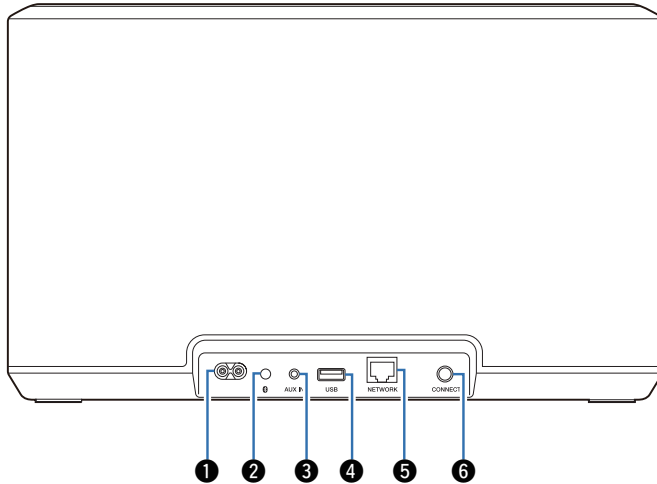

① AC inlet

Used to connect the power cord. (👉 p. 13)

② Bluetooth button (📶)

Used in the Bluetooth pairing settings. (👉 p. 23)

③ AUX input connector (AUX IN)

Used to connect audio devices. (👉 p. 21)

④ USB port

Used to connect USB memory devices. (👉 p. 22)

⑤ NETWORK connector

Used to connect this unit to a wired Ethernet network. (👉 p. 16)

⑥ CONNECT button

Used for Wi-Fi setup. (👉 p. 54)

■ Bottom panel

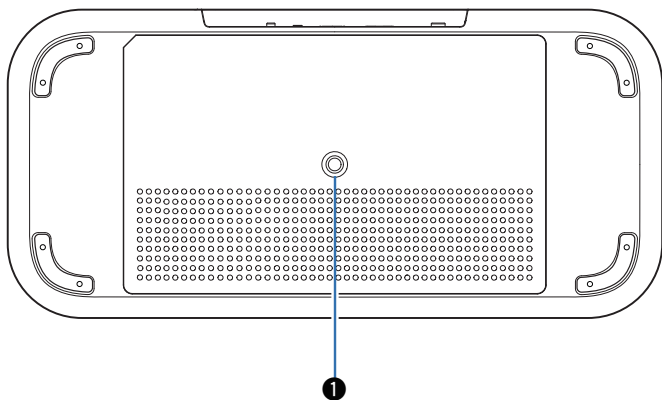

1 Mounting screw hole

Used when mounting this unit to the wall or ceiling. (👉 p. 12)

Placing your speaker

You can place your speaker anywhere you want to enjoy great sounding music. Please follow these simple guidelines when determining where to place your speaker...

- The speaker must be within range of your wireless network.
- The speaker is designed to sound best when placed 3 to 12 inches (8 - 30 cm) from a wall.
- Locate the speaker at least 12 inches (30 cm) from a television, computer, or other display device to avoid the possibility of interference.
- Place the speaker across the room from where you will be listening, as close to ear level as possible.
- The speaker is not waterproof. Do not place it near any water source and do not leave it outside in the rain or snow.

■ Wall or ceiling mounting

This speaker can be mounted on a wall or ceiling using a screw included and standard speaker or camera mount/attachment (1/4 inches / 6.35 mm diameter) that supports at least 59 lbs 1 oz / 26.8 kg. For more information, contact the store you purchased the speaker.

Caution

- Use a hexagonal wrench with a width across flats of 3/16 inches / 4.8 mm for the included screw.
- Do not use a fixture other than the included screw to mount the speaker on a wall. This may damage the speaker.
- Use a commercial bracket (sold separately) to attach this unit to the wall or ceiling. Do not attach it directly to the wall or ceiling.
- If attaching this unit to the wall or ceiling, check that it is attached securely. Please be aware that Denon accepts no responsibility for any damage if the unit falls.

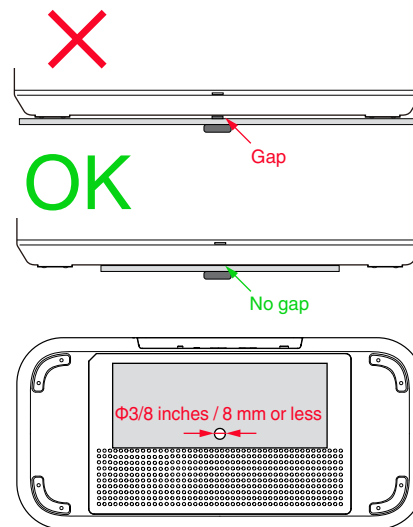

Do not obstruct the ventilation holes.

Powering your speaker

Connect the power cord included in the box to the rear panel of the speaker and the plug to a wall outlet. The speaker is capable of automatically switching between 100 - 240 V.

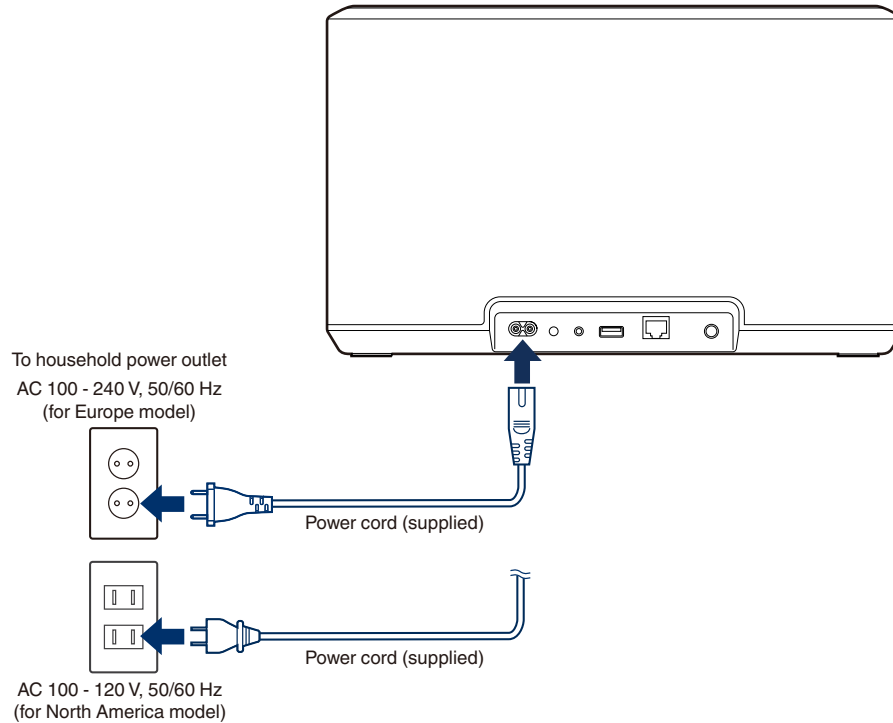

Getting the HEOS app

The HEOS app is the heart of the HEOS system experience. Using your mobile device and the HEOS app, you can setup, browse, explore, and control your HEOS system right in the palm of your hand, from anywhere in your home.

Download the HEOS app for iOS or Android by searching App Store®, Google Play™ store or Amazon App Store for “HEOS”.



For the purpose of improvement, the specifications and design are subject to change without notice.

Setting up your first speaker

Once you have placed your speaker in your listening room and have downloaded the HEOS app, you are ready to configure your speaker for music playback. This involves following a few simple steps to get the speaker connected to your existing home network:

Caution

- Do not connect the Ethernet cable if you are connecting your speaker to a wireless network. If you are connecting the speaker to a wired network, use an Ethernet cable sold separately to connect the speaker to your network or router.

1 Make sure your mobile device is connected to your wireless network (the same network you want your speakers connected to).

You can check this in the “Settings” - “Wi-Fi” menu of your iOS or Android device.

NOTE

- Activate the Bluetooth setting on your mobile device.
- If your wireless network is secure, make sure you know the password to join your network.

2 Launch the HEOS app on your mobile device.



3 Tap the “Setup Now” button at the top of the screen.

4 Follow the instructions to add the speaker to your wireless network.

NOTE

- If you have any problems connecting your speaker, jump to the Troubleshooting section (🔍 p. 51).

Adding more speakers

The HEOS system is a true multiroom audio system that automatically synchronizes audio playback between multiple speakers so that the audio coming from different rooms is perfectly in sync and always sounds amazing! You can easily add up to 32 speakers to your HEOS system.

Adding wired speakers

Just connect the speaker to your home network using an Ethernet cable and the speaker will appear on your HEOS app as a new room in the “Rooms” screen.

At your convenience, you can assign a name to the speaker to indicate which room you have it placed in.



- Use only a shielded STP or ScTP LAN cable which is easily available at electronics stores (CAT-5 or greater recommended).
- Do not connect a NETWORK connector directly to the LAN port/Ethernet connector on your computer.

Adding wireless speakers

You can add additional speakers to your HEOS system by selecting “Add Device” from the HEOS app’s settings menu and follow the instructions:

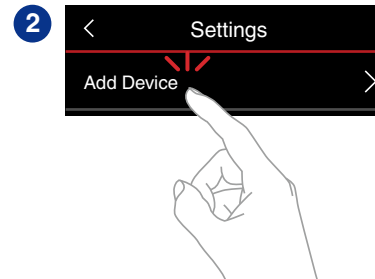
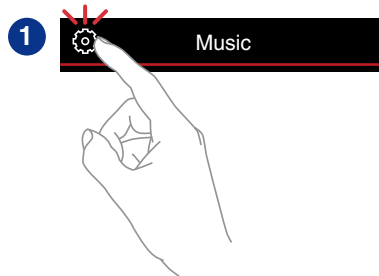

Using your speaker

Once you have your speaker connected to your network and the HEOS app installed on your mobile device, it's easy to start enjoying your favorite music. You can listen to something different on every speaker or the same music perfectly synchronized on all speakers. It's up to you!

Selecting a room/speaker

If you have more than one speaker, you must tell the HEOS system which speaker you want to control:

- 1 Tap the “Rooms” tab.
- 2 Select the Room/Speaker you want to control.
- 3 Select the “Music” tab to select a music source or the “Now Playing” tab to control what is currently playing in the selected room.

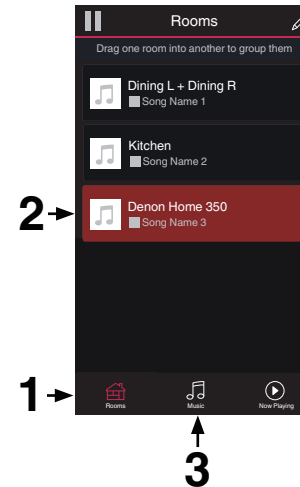

Quick Select function

Input source settings can be registered to the Quick select buttons (1 - 6).

- 1 To register the current settings, press and hold down one of the Quick Select buttons (1 - 6) on the top panel for 3 seconds.**



- The status LED blinks once when registration is complete.
- To recall the registered settings, press the Quick Select button on the top panel.

[Default settings]

Button	Input source
Quick Select 1	AUX In
Quick Select 2	—
Quick Select 3	—
Quick Select 4	—
Quick Select 5	—
Quick Select 6	—

Listening to radio

The HEOS system includes access to more than 100,000 free internet radio streams from all corners of the globe via the Tuneln radio service. Just select the Tuneln logo from the main “Music” menu and browse among the 100,000 stations neatly organized into popular categories and select a station that appeals to your mood.

NOTE

- If you have a Tuneln account, you can sign into the Tuneln service under “Settings” - “Music Sources” - “Tuneln”, and access all of your “My Favorites” Tuneln stations.

■ ■ ■ Audio signal

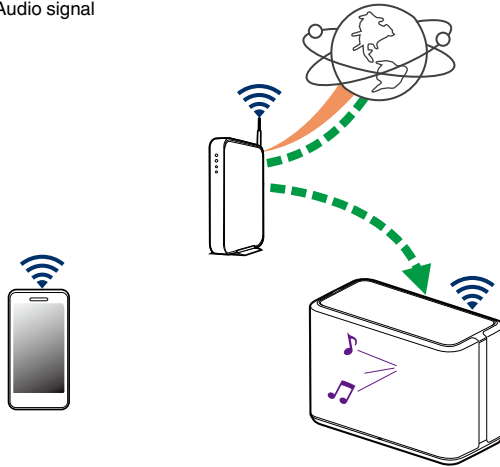

Playing music stored on your mobile device

- 1 Tap the “Music” tab.
- 2 Select “This iPhone/iPod/iPad/Phone”.
- 3 Browse the local music on your phone and select something to play.

■ ■ ■ Audio signal

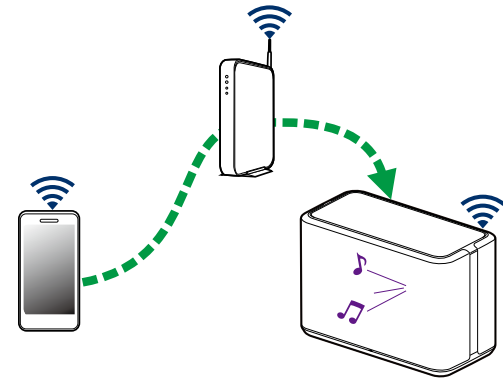

Playing music from your networked PC or NAS

- 1 Select “Music Servers” from the “Music” tab.
- 2 Select the name of your networked PC or NAS (Network Attached Storage) server.
- 3 Browse the music on your PC/NAS and select something to play.

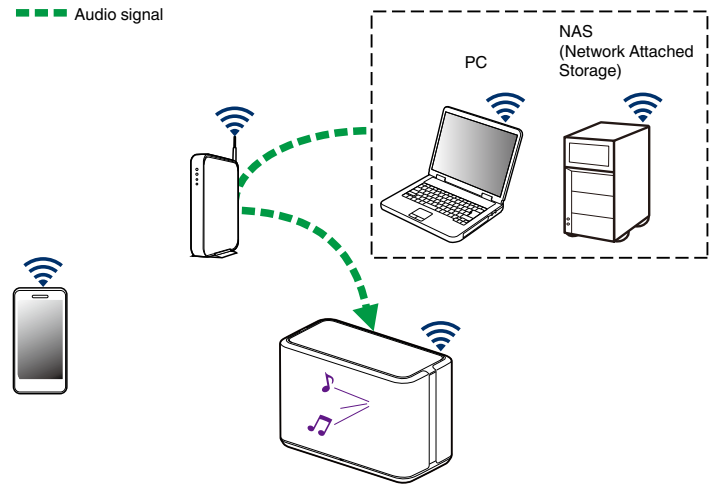

Playing music from the AUX input

1 Connect an audio device with a 3.5 mm stereo audio output to the AUX input on your speaker using a 3.5 mm stereo audio cable sold separately.

When a 3.5 mm stereo audio cable is connected to “AUX IN”, the source automatically switches to Inputs.

NOTE

- When there is a cable connected to AUX IN, select “Inputs” from the “Music” tab.

2 Initiate playback on the audio device.



- The sound from the audio device can be played directly on the selected speaker or digitized and sent over your network to other speakers.

NOTE

- The analog output signals from some sources can be fairly strong. If the input level of the source device is turned up high, it could overload the inputs of the speaker. This is unlikely to cause damage, but can cause distorted sound. Initially, set the volume of the source to a medium – low level, then turn it up as needed. If you hear distortion, turn down the device's volume control.

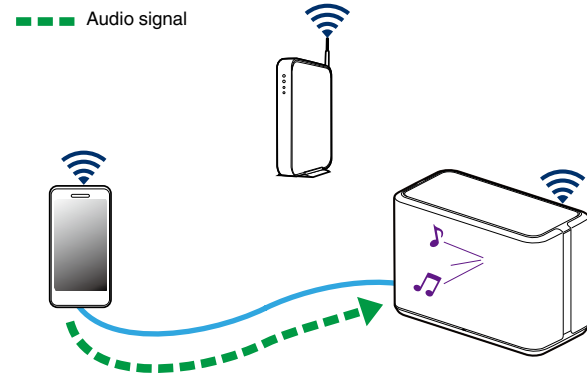

Playing music from a USB memory device

- 1** Insert a FAT32 or NTFS formatted USB memory device into the USB port on the rear panel of the speaker.
- 2** Select “USB Music” from the “Music” tab.
- 3** Select the name of your speaker.
- 4** Browse the music on your USB memory device and select something to play.

NOTE

- It may take several minutes for the name of your speaker to appear in the “USB Music” list if you have a large number of files on your USB memory device.
- It is not possible to connect and use a computer via the USB port of this unit using a USB cable.

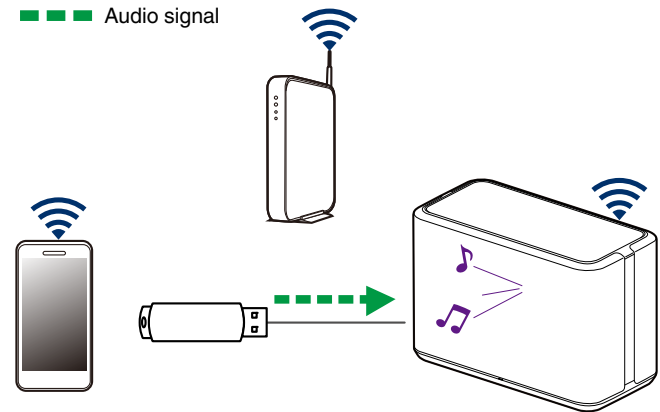

Playing music from Bluetooth device

■ Pairing the speaker with your Bluetooth devices

- 1 Activate the Bluetooth setting on your mobile device.
- 2 Press and hold the Bluetooth button (📶) located on the rear panel of the speaker for 3 seconds and release the button when you see a pattern of two green flashes on the status LED.

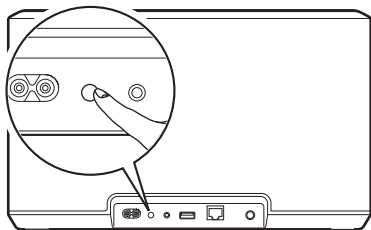

- 3 Select “Denon Home 350” from the list of available Bluetooth devices.

In a few seconds your mobile device will indicate that it is connected to your speaker.

- 4 Play music using any app on your device.

The sound will now play from the speaker.

■ ■ ■ Audio signal

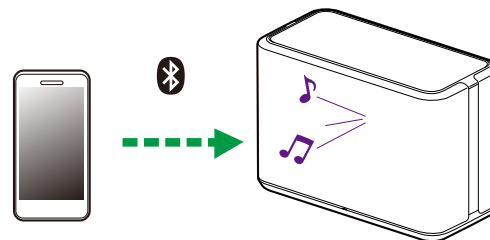

NOTE

- Disconnect and reconnect Bluetooth connections from your Bluetooth device.

HEOS account

■ What is a HEOS account?

A HEOS account is master account or “keychain” for managing all of your music services with one single username and password.

■ Why do I need a HEOS account?

With the HEOS account you just have to enter your music services login names and passwords one time. This allows you to easily and quickly use multiple controller apps on different devices. You just log into your HEOS account on any device and you will have access to all of your associated music services, play history and custom playlists, even if you are at a friend’s house listening to music on their HEOS system.

■ Signing up for a HEOS account

You will be instructed to signup for a HEOS account the first time you try to access any music service from the main “Music” menu of the HEOS app.

■ Changing your HEOS account

- 1 Tap the “Music” tab.
- 2 Select the Settings  icon in the upper left corner of the screen.
- 3 Select “HEOS Account”.
- 4 Change your location, change your password, delete your account or sign out of your account.

Playing from streaming music services

A music service is an online music company that provides access to vast music collections via free and/or paid subscriptions. Depending upon your geographical location, there are several options to choose from.

NOTE

- The HEOS app and brand is not affiliated with any manufacturer of any mobile device. Availability of music services may vary by region. Not all services may be available at time of purchase. Some services may be added or discontinued from time to time based on decisions of the music service providers or others.

■ Adding a music service

Once you've setup your HEOS account, you can add supported music services to your HEOS system by tapping on the music service logo in the "Music" tab.

Follow the instructions on the screen to add your username and password for the selected music service. You only have to enter your account information once as the HEOS account service will securely remember your login information so you don't have to enter it each time you want to play music from the music service.

Additional music services may be available under "Settings" - "Music Sources" - "Online Music".

■ Changing music service settings

- 1 Tap the "Music" tab.
- 2 Select the Settings  icon in the upper left corner of the screen.
- 3 Select "Music Sources".
- 4 Select "Online Music".
- 5 Select the name of the online music service you want to edit.
- 6 Sign out, then sign in again to associate your username and password with your HEOS account.
- 7 Select "Hide for Now" to prevent the service logo from appearing on the main "Music" menu.

Managing inputs

If you connected external audio source components to any of your speakers inputs, you can rename the default input names to describe the actual source or hide any inputs that are not being used.

- 1** Select the Settings  icon located in the upper left corner of the main “Music” menu to display the Settings menu.
- 2** Select “Music Sources”.
- 3** Select “Inputs”.
- 4** Select the speaker which you connect your external audio source device to.

■ Changing the name of the inputs

- 1** Select the name of the input you want to edit.
- 2** Select “Name”.
- 3** Select or enter a new name to describe the source that you connected.
- 4** Select the Save button to save your changes.

■ Hiding an input

- 1** Select the name of the input you want to edit.
- 2** Toggle “Hide Input” to ON to prevent this input from appearing under the Inputs tile on the main “Music” menu.

Managing your phone

Your smartphone or tablet can be hidden if it does not need to be in the “Music Sources” menu.

- 1** Select the **Settings**  icon located in the upper left corner of the main “Music” menu to display the Settings menu.
- 2** Select “Music Sources”.
- 3** Select “This iPhone/iPod/iPad/Phone”.
- 4** Toggle “This iPhone/iPod/iPad/Phone” to OFF to prevent the service logo from appearing on the main “Music” menu.

Listening to the same music in multiple rooms

The HEOS system is a true multiroom audio system that automatically synchronizes audio playback between multiple speakers so that the audio coming from different rooms is perfectly in sync and always sounds amazing!

You can easily add up to 32 speakers to your HEOS system.

You can join or group up to 16 individual speakers into a group of speakers that function as if they were a single speaker.

■ Grouping rooms

- 1 Press and hold your finger on room that is not playing music.**
- 2 Drag it into the room that is playing music (indicated by the red outline) and lift your finger.**

The two rooms will be grouped together into a single device group and both rooms will be playing the same music in perfect sync.

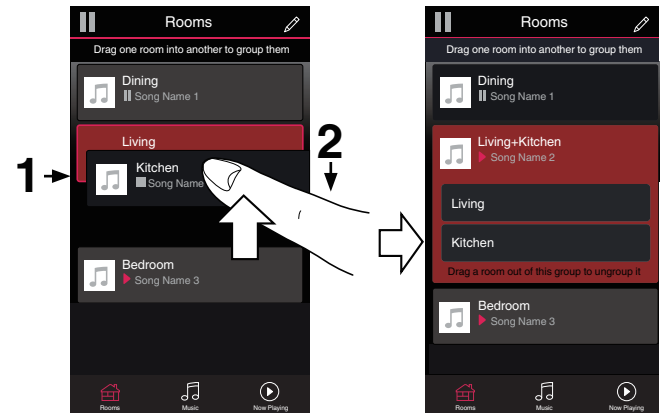

■ Ungrouping rooms

- 1 Press and hold your finger on room that you want to remove from the group.**

NOTE

- You can not remove the first room that started playing the music before grouping.

- 2 Drag it out of the group and lift your finger.**

Music will stop playing in the room you dragged out of the group but will continue playing in any remaining rooms.

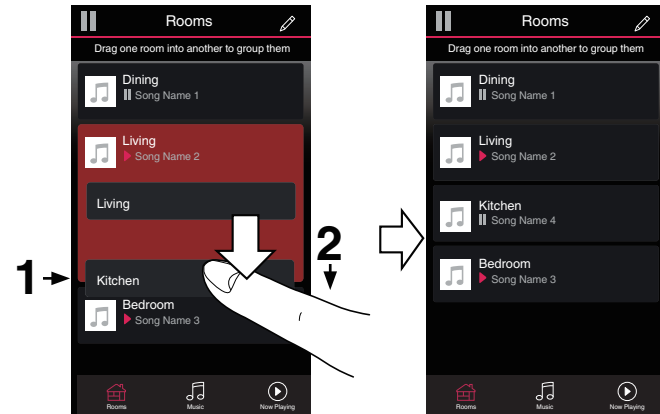

■ Grouping all rooms (party mode)

You can easily group 16 rooms together into Party Mode by using a “pinch” gesture.

1 Place two fingers on the screen over the list of rooms.

2 Quickly pinch your two fingers together and release.

All of your rooms will be joined together and begin playing the same music in perfect sync.



■ Ungrouping all rooms

You can easily ungroup all of your rooms and exit Party Mode by using a “spread” gesture.

- 1 Place two fingers close together on the screen over list of rooms.**
- 2 Quickly spread your two fingers apart from each other and release.**

All of your rooms will be ungrouped and music will stop playing in every room (except the original “master” room that was playing before you grouped the rooms together).



Stereo pairing

■ Creating a stereo pair

A matching pair of speakers that have been grouped together (see above) can be saved as a persistent stereo pair where one speaker outputs the left channel of audio and the other speaker outputs the right channel of audio. Paired speakers will then appear as a single room (with two speakers playing music) in the Rooms list.

- 1 Tap the “Rooms” tab.
- 2 Create a group containing **ONLY** two matching speakers (see “Grouping rooms” (p. 28)).
- 3 Tap the Pencil  icon to enter Edit mode.
- 4 Tap on the Group of two matching speakers to Edit the Group.

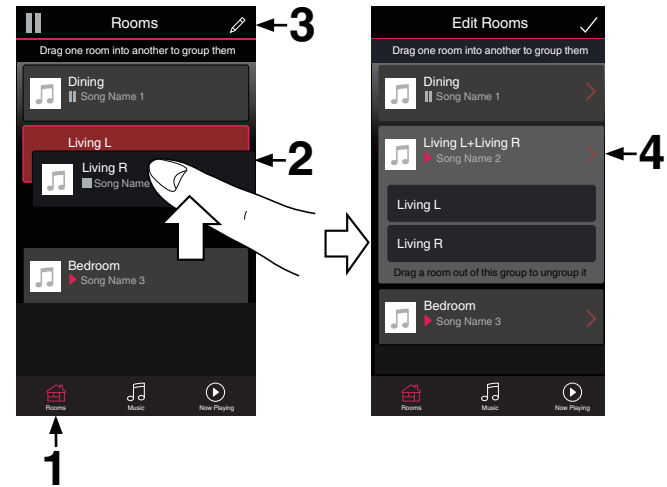

5 Tap on the Stereo Pair switch to pair the two speakers.



6 Tap the Back arrow  to return to the list of Rooms.

7 Tap the Check Mark  icon to exit Edit mode.

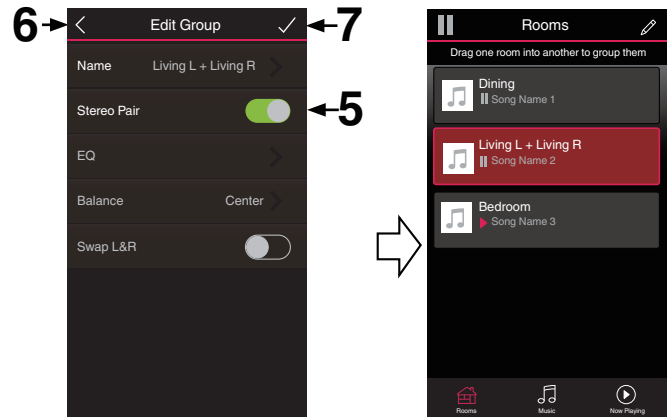

The group of two matching speakers will now appear as a single room. You can change the name of the stereo paired room at any time.





■ Changing the name of a stereo pair

- 1 Tap the “Rooms” tab.
- 2 Tap the Pencil  icon to enter Edit mode.
- 3 Tap a Stereo Pair (a room which contains two matching speakers) to edit the group.
- 4 Tap “Name”.
- 5 Select or enter a new name for your pair of speakers.
- 6 Tap the Save  button to save your changes.



■ Adjusting the balance

- 1 Tap the “Rooms” tab.
- 2 Tap the Pencil  icon to enter Edit mode.
- 3 Tap a Stereo Pair (a room which contains two matching speakers) to edit the group.
- 4 Select “Balance”.
- 5 Adjust the Balance to the left or right.
- 6 Tap the Check Mark  icon to exit Edit mode.

■ Swapping left and right channels in a stereo pair

- 1 Tap the “Rooms” tab.
- 2 Tap the Pencil  icon to enter Edit mode.
- 3 Tap a Stereo Pair (a room which contains two matching speakers) to edit the group.
- 4 Tap on the Swap L&R switch to swap the left and right channels of the two speakers.
- 5 Tap the Back arrow  to return to the list of Rooms.
- 6 Tap the Check Mark  icon to exit Edit mode.

■ Removing a stereo pair

- 1 Tap the “Rooms” tab.
- 2 Tap the Pencil  icon to enter Edit mode.
- 3 Tap a Stereo Pair (a room which contains two matching speakers) to edit the group.
- 4 Tap on the Stereo Pair switch to return the paired speakers to two individual speakers.
- 5 Tap the Back arrow  to return to the list of Rooms.
- 6 Tap the Check Mark  icon to exit Edit mode.

Using the now playing queue

HEOS system uses a Now Playing “Queue” to line up music that you want to listen to. Music can be selected from any of your local or online music sources (as long as they are not preprogrammed “radio” or “station” type streams). This feature works similarly to how a jukebox works. You select something to play (a song, album, playlist or even your entire music collection) and add it to the “Queue”. When you select something to play you will be asked how you want to queue up your music.

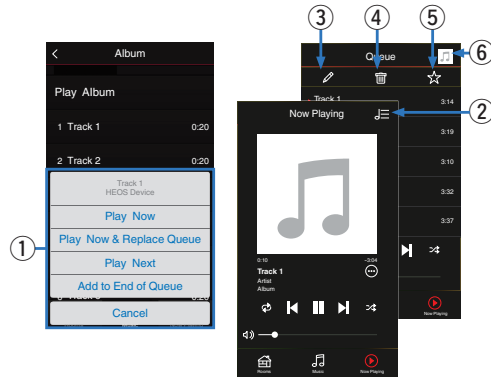

1 Queue Menu

When you select something to play you will be asked how you want to queue up your music.

2 Queue icon

3 Pencil icon

4 Delete icon

5 Save icon

6 Cover art or HEOS icon

You can return to the “Now Playing” screen display by tapping the cover art or the HEOS icon.

■ Play Now

Inserts the item into the queue after the currently playing track and plays the selected item immediately.

■ Play Now & Replace Queue

Clears the queue and plays the selected item immediately.

■ Play Next



Inserts the item into the queue after the current song and plays it when the current song ends.

■ Add to End of Queue

Adds the item to the end of the queue.



Rearranging the now playing queue

Once you have songs lined up in your queue, you might want to rearrange the order or remove some songs:

- 1 Tap the “Now Playing” tab.
- 2 Tap the Queue  icon in the upper right corner of the screen.
- 3 Tap the Pencil  icon to enter Edit mode.
- 4 Rearrange the order of your queue by dragging the list  icon (on the right side of each track row) up or down.



Deleting songs from the play queue

You can remove songs one at a time from the Now Playing Queue:

- 1 Tap the “Now Playing” tab.
- 2 Tap the Queue  icon in the upper right corner of the screen.
- 3 Tap the Pencil  icon to enter Edit mode.
- 4 Tap the track(s) that you want to delete.
- 5 Tap the Delete  icon to delete all of the selected tracks from the play queue.



Deleting all songs from the play queue

You can remove all of the songs from the Now Playing Queue:

- 1 Tap the “Now Playing” tab.
- 2 Tap the Queue  icon in the upper right corner of the screen.
- 3 Tap the Delete  icon to confirm that you want to delete all songs from the queue.



Saving playlists

You can save the Now Playing Queue as a HEOS Playlist that you can recall later. The new playlist will be available from the Playlists button on the “Music” tab on every controller app connected to your HEOS system.

- 1 Tap the “Now Playing” tab.
- 2 Tap the Queue  icon in the upper right corner of the screen.
- 3 Tap on the Save  icon.
- 4 Enter a name for your Playlist and tap the  icon.

Performing repeat and shuffle playback

The playback controls are visible on the “Now Playing” screen.

- 1 Tap the “Now Playing” tab.
- 2 Tap the repeat  and shuffle  controls.

Using the favorite

HEOS system uses a "HEOS Favorites" to line up station you want to start play quickly the favorite stations.

Station can be selected from online music sources such as "Radio" or "Station" type streams. "HEOS Favorites" will display a list of the stations of various services.

■ Adding to HEOS favorite

Select a station of an online music source. When the action menu screen is displayed, select "Add Station to HEOS Favorites".

NOTE

- This can also be done by selecting "Add Station to HEOS Favorites" from the station menu of the station being played.

■ Deleting station from the HEOS favorite

- 1 Tap the "Music" tab.
- 2 Select "Favorites".
- 3 Tap the Pencil  icon to enter Edit mode.
- 4 Tap the "Delete" that you want to delete station.

AirPlay function

Music files stored on your iPhone, iPod touch, iPad or iTunes can be played on this unit via the network.

■ ■ ■ Audio signal

NOTE

- The screen may differ depending on the OS and software versions.

This device supports AirPlay 2®.

Sync multiple AirPlay 2 compatible devices/speakers for simultaneous playback.



- This unit supports AirPlay 2 and requires iOS 11.4 or later.

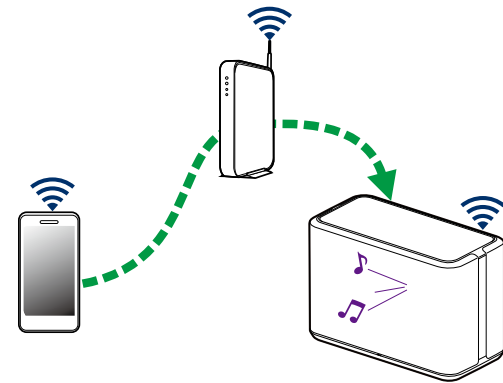

Playing songs from your iPhone, iPod touch or iPad

If you update your “iPhone/iPod touch/iPad” to iOS 4.2.1 or later, you can stream music stored in your “iPhone/iPod touch/iPad” directly to this unit.

1 Connect your iPhone, iPod touch or iPad Wi-Fi to the same network as this unit.

- For details, see your device’s manual.

2 Play the song on your iPhone, iPod touch or iPad.

AirPlay icon is displayed on the iPhone, iPod touch or iPad screen.

3 Tap the AirPlay icon and select this unit.

[Example] iOS 12



[Example] iOS 9



Playing iTunes music with your speaker

1 Install iTunes 10, or later, on a Mac or Windows PC that is connected to the same network as this unit.

2 Start iTunes and click the AirPlay icon to select this unit.

[Example] iTunes

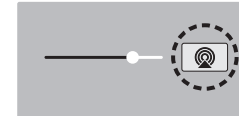

3 Choose a song and click play in iTunes.

The music will stream to this unit.

Play a song from your iPhone, iPod touch or iPad on multiple synced devices (AirPlay 2)

Songs from an iPhone, iPod touch or iPad operating iOS 11.4 or later can be synced with multiple AirPlay 2 supported devices for simultaneous playback.

1 Play the song on your iPhone, iPod touch or iPad.

AirPlay icon is displayed on the iPhone, iPod touch or iPad screen.

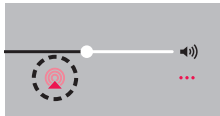

2 Tap the AirPlay icon.

Displays a list of devices/speakers that can be played back on the same network.

- A circle is displayed to the right of AirPlay 2 compatible devices.

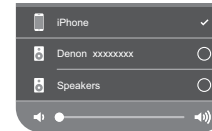

3 Tap the devices/speakers you want to use.

- Multiple AirPlay 2 compatible devices can be selected.
- Volume can be adjusted for each device individually or for all synced devices simultaneously.



Making speaker adjustments

You can adjust specific settings for each of your speakers in your system:

- 1** Select the **Settings**  icon located in the upper left corner of the main “Music” menu to display the **Settings** menu.
- 2** Select “**My Devices**” to display a list of your speakers.
- 3** Select the speaker you want to adjust.

Changing the name of a speaker

- 1** Select “**Name**”.
- 2** Select or enter a new name for your speaker.
- 3** Tap the  icon to save your changes.

Changing the wireless network connection

- 1** Select “**Network**”.
A list of wireless networks that your speaker can access is displayed.
- 2** Select the network you want your speaker to join.
Wait as the speaker’s network connection is changed.

NOTE

- Wired networking is automatically selected when the speaker is connected to a wired Ethernet network. To switch back to using a wireless network you must remove the Ethernet cable from the rear panel of the speaker.

Changing the speaker's equalizer

- 1 Select "EQ".
- 2 Adjust the "Treble" or "Bass" up or down.

NOTE

- Select the Reset button to restore the default settings.

Adjusting the audio quality

Selects the transcoding option for rebroadcasting audio from one speaker to another speaker (or group of devices) across the network. When set to high bit rate audio sources originating from the first device (such as analog input, WAV, FLAC and PCM) will be transcoded to ensure the highest level of reliability for the audio stream.

- 1 Select "Quality".
- 2 Select "Normal" (default) or "High".



- If you have selected "High" and you experience audio dropouts when streaming sources from one device to other devices, please select "Normal" (default).

Adjusting the status light brightness

- 1 Select "Status Light".
- 2 Adjust the brightness up or down or set the slider to the OFF position to completely disable the status light.

Advanced speaker settings

Caution

- Adjusting these settings may disconnect your speaker from your network and possibly render your speaker unusable. Do not use these features unless you are comfortable making advanced adjustments to your speaker.

■ Network settings

- 1** Select “Advanced”.
- 2** Select “NETWORK SETTINGS” tab.
- 3** Scroll down to see all of the options for
 - a. Network Interface (Ethernet or Wireless)
 - b. Wireless Settings
 - c. IP Address Settings (Automatic or Manual)
 - d. Wireless Power Saving
- 4** Select “Save Settings” to apply the new settings or “Cancel Changes” to revert to the previous settings.

■ About wireless power saving

The Wireless Power Savings feature saves power by turning off power to the wireless radio inside the speaker when the device is connected to an Ethernet network. If you disconnect the Ethernet cable from the speaker, Wireless Power Saving will automatically turn off and the wireless radio will turn on so that the speaker can be discovered over your wireless network.

NOTE

- If Wireless Power Savings is ON, Wi-Fi power will be temporarily turned on when accessing the “My Devices” - (“Device Name”) - “Network” screen in the HEOS app or whenever the CONNECT button on the device is pressed.

■ Firmware upgrade

- 1 Select “Advanced”.
- 2 Select “FIRMWARE UPDATE” tab.
 - Update status

 - Manually check for a firmware upgrade.

 - Allow updates

 - ON
(Default): Allows updates

 - OFF: Does not allow updates

- 3 Select “Save Settings” to apply the new settings or “Cancel Changes” to revert to the previous settings.

■ About

Viewing technical details about the speaker.

- 1 Select “Advanced”.
- 2 Select “ABOUT” tab.
- 3 Scroll down to see information about the speaker’s.
 - a. Hardware
 - b. Software
 - c. Device

Updating your system

HEOS system has the ability to add enhancements and updated functionality via your high speed Internet connection. Follow the instructions on the screen to update the speaker and/or your controller app.

1 Select the **Settings**  icon located in the upper left corner of the main “Music” menu to display the **Settings** menu.

2 Select “**Software Update**”.

Check for Update

Follow the instructions on screen to install any available updates to your HEOS system.

Auto-Update

ON
(Default):

Valid updates are performed automatically.

OFF:

You will be notified of valid updates on the HEOS app.

Advanced features

There are a few advanced features of the HEOS system that you may want to explore once you become familiar with the basic operations. You can access the advanced features of the HEOS system by following these steps:

- 1** Select the **Settings**  icon located in the upper left corner of the main “Music” menu to display the **Settings** menu.
- 2** Select “**Advanced Settings**” to display a list the available settings.

Sharing music from your mobile device

The HEOS app has a feature called “Music Sharing” which can share the local music stored on your mobile device to other HEOS app users on your local network. To enable this feature, select “Music Sharing”, and set it on “ON”.

The name of the device you are sharing from will appear as a music server allowing other HEOS apps to browse and play music from the your device.

Wireless performance

You can check the wireless connection status of your speaker.

Quality

Excellent / Good / Poor

NOTE

- If the quality level of your speaker is “Poor”, make sure your speakers are not located near other electronic devices that could interfere with it’s wireless connectivity (like microwave ovens, cordless phones, TVs, etc...)

Signal

Excellent / Good / Poor

NOTE

- If the signal level of your speaker is “Poor”, make sure your speakers are within range of your wireless network.

Submit diagnostics

If you are having trouble with your network or HEOS system, you may be asked by Denon technical support personnel to select this option. This feature will automatically send Denon technical support diagnostic information about your HEOS system.

NOTE

- No personal information is sent and your information will never be shared with anyone.

Resetting your controller app

This feature will reset the control app to its original state when you first installed it on your mobile device without requiring you to remove, download, and reinstall it from the app store.

Power management

Power modes

■ Quick Start Mode

This speaker automatically enters "Quick Start Mode" to save power in the following cases. During "Quick Start Mode", speaker operations cause the power to turn on.

During "Quick Start Mode", the status LED lights in dim blue.

❑ Ethernet

After around 20 minutes of no operation and no network access after playing music via Ethernet.

❑ Wi-Fi

After around 20 minutes of no operation and no network access after playing music via Wi-Fi.

❑ USB

After around 20 minutes of no operation and no network access after playing music from a USB memory device.

❑ Bluetooth

After the Bluetooth connection is disconnected and there is around 20 minutes of no operation and no network access after playing music via Bluetooth.

❑ AUX IN

After around 20 minutes of no audio.

■ Deep Standby

The device also has the ability to automatically enter "Deep Standby" whenever the wired or wireless network connection is removed for more than 60 minutes in "Quick Start Mode". The front panel LED will turn off during Deep Standby.

Press any button to turn the power on.



- You also press the ►|| button for 5 seconds, the device enters the Deep Standby.

■ Off

To completely turn off the power to the device you must remove the mains plug from the power outlet.

Basic troubleshooting

Cannot connect the speaker to the network

Solution	Refer to Page
<ul style="list-style-type: none">• Make sure your mobile device is connected to your wireless network before setting up your speaker.	15
<ul style="list-style-type: none">• Alternatively, you can connect your speaker to your network router using an Ethernet cable sold separately. Once connected via Ethernet, the HEOS app should recognize the speaker and you can manually move it to your wireless network using “Settings” - “My Devices” - (“Device Name”) - “Advanced” - “Network Settings”.	16

Cannot pair a Bluetooth mobile device with the speaker

Solution	Refer to Page
<ul style="list-style-type: none">• The connection from the Bluetooth mobile device is malfunctioning. Power cycle the mobile device, remove the pairing information and re-pair the speaker to the mobile device.	–

Cannot hear Bluetooth music

Solution	Refer to Page
• Your Bluetooth mobile device is not paired with speaker. Re-pair the speaker to the mobile device.	—
• The speaker is Wi-Fi mode or Aux-in mode etc. Pair and connect Bluetooth device to speaker.	—
• The Bluetooth mobile device is connected to another audio device. Make sure your Bluetooth device is connected to speaker.	—
• The volume on Bluetooth mobile device is too low. Check the volume on the Bluetooth mobile device. Check the volume on the speaker.	—

Music cuts out or delays sometimes

Solution	Refer to Page
• Make sure your Internet connection is operating correctly. If you are sharing your network with other users or devices, they may be using most of your bandwidth (especially if they are streaming video).	6
• Make sure your speakers are within range of your wireless network.	48
• Make sure your speakers are not located near other electronic devices that could interfere with it's wireless connectivity (like microwave ovens, cordless phones, TVs, etc...).	48

I hear a delay when using the AUX input with my TV

Solution	Refer to Page
<ul style="list-style-type: none"> If you are connecting the AUX input with your cable or satellite box for enjoying TV audio through multiple speakers, you may hear a delay between when you see someone speak and when you hear the audio. This is because the HEOS system must buffer the audio before it sends it out to the speakers so that it arrives at all speakers at the same time. 	21
<ul style="list-style-type: none"> You can avoid this delay by listening only to the speaker which is directly connected to the set top box. 	—

Connecting to a network using an iOS device

Solution	Refer to Page
<p>This speaker supports Apple's "WAC (Wireless Accessory Configuration)" setup mode. WAC setup mode allows you to connect your speaker to your network without requiring you to type in the network name and password.</p> <ol style="list-style-type: none"> Press and hold - and ► buttons for 3 seconds. Go to the Wi-Fi menu under Settings on your iOS device. Select "Denon Home 350" under "SET UP NEW AIRPLAY SPEAKER..." at the bottom of the list. Select the network you want your speaker to connect to and select "Next". Follow the instructions on the screen to complete setup. <p>HEOS system will stay in WAC setup mode for 15 minutes. If the device is not setup within 15 minutes, it will revert back to its previous network connection. Press the ► button if you want to cancel WAC setup mode.</p> <p>The status LED will quickly blink 5 times.</p>	—

I hear distortion when using the AUX input

Solution	Refer to Page
<ul style="list-style-type: none">The analog output signals from some sources can be fairly strong. If the input level of the source device is turned up high, it could overload the inputs of the speaker. This is unlikely to cause damage, but can cause distorted sound. Initially, set the volume of the source to a medium – low level, then turn it up as needed. If you hear distortion, turn down the device's volume control.	—

Connecting to a WPS network

Solution	Refer to Page
<p>If your wireless router support WPS (Wi-Fi Protected Setup™) your speaker can optionally connect to your network using the "Push Button" method by following these steps:</p> <p>Wi-Fi Protected Setup™ is trademarks of Wi-Fi Alliance.</p> <ol style="list-style-type: none">Press the WPS button on your router.Within 2 minutes, press and hold the CONNECT button on the rear panel of the speaker for 3 seconds.The LED on the front of the speaker will flash green for several seconds as it connects to your WPS router.When the connection is complete, the LED on the front of the speaker will turn solid blue.	6

Resetting your speaker





Solution	Refer to Page
<p>Resetting your speaker will clear out the wireless network info, EQ, and name but retain it's current software. You will have to use "Settings" - "Add Device" to reconnect the speaker to your home network before it can be used.</p> <p>To reset your speaker, press and hold the CONNECT and Bluetooth (📶) buttons located on the rear panel of the speaker for 5 seconds until the front LED begins to flash amber.</p>	-

Buttons do not operate correctly





Solution	Refer to Page
<ul style="list-style-type: none"> Do not put anything on top of the speaker. 	-
<ul style="list-style-type: none"> Items near the top of the speaker (curtains, steel racks, etc.) may cause unintended button activation. 	-
<ul style="list-style-type: none"> Set up the speaker where there is nothing nearby. 	-
<ul style="list-style-type: none"> Unplug the power cord before cleaning the top panel. 	-



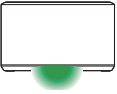
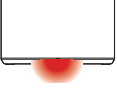

Status LED table

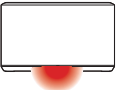
The LEDs on the front panel change to indicate the current speaker status.

Speaker status	LED action	Description
Deep Standby mode	 (off)	Power is off, or the speaker is in Deep Standby mode. (☞ p. 50)
Quick Start mode	 (dimmed solid)	Speaker is in Quick Start mode. (☞ p. 50)
Power on	 (blink)	Speaker is starting up or connecting to the network.
	 (solid)	Speaker is connected to the network.
	 (solid)	Speaker is unable to connect to the network. Try to connect the speaker again.

Speaker status	LED action	Description
WPS	 (fast blink)	Speaker is connecting to the network via WPS.
	 (for 3 sec. solid)	Speaker is connected to the network via WPS.
	 (for 3 sec. solid)	WPS has timed out.

Speaker status	LED action	Description
Bluetooth	 (two blinks)	Speaker is pairing via Bluetooth.
	 (one blink)	Speaker is paired via Bluetooth.
	 (for 3 sec. solid)	Speaker failed to pair to the Bluetooth device. Try to pair again. (👉 p. 23)
Volume setting	 (quick blink)	Volume is being adjusted.
	 (slow blink)	Speaker is muted.

Speaker status	LED action	Description
Firmware update	 (blink)	Firmware is being updated.
	 (slow blink (Not fade))	There is a firmware error. Check your usage environment, relaunch the app, then try to update the firmware again. (👉 p. 46)
Error	 (solid)	There was a setup error. Check your usage environment, then follow the correct procedure to try setup again. If the error occurs again, restore factory settings and try setup again. (👉 p. 55)
	 (fast blink)	There is a hardware error. Unplug the power cord, wait a little while, then plug the power cord back in.
Reset	 (blink)	Factory settings have been restored.

Supported file types and codecs

Frequency	Sample Rate	File Extension	Codec	Bit Rates
32/44.1/48 88.2/96/176.4 192 kHz	16/24 bit	wav	PCM	---
32 kHz 44.1 kHz 48 kHz	16 bit	mp3	MPEG-1 Audio Layer 3 CBR/VBR	32 - 320 kbps
32 kHz 44.1 kHz 48 kHz	16 bit	m4a aac	AAC-LC	48 - 320 kbps
32 kHz 44.1 kHz 48 kHz	16 bit	wma	wma9 CBR	CBR:48 - 192 kbps
44.1/48 88.2/96/176.4 192 kHz	16/24 bit	flac	flac	---
44.1/48 88.2/96/176.4 192 kHz	16/24 bit	m4a	ALAC	---
2.8/5.6 MHz	1 bit	dff dsf	DSDIFF DSF	---

NOTE

- Files protected by DRM such as Apple's Fairplay DRM, are not supported.
- If you select a music source with a high bit rate or high resolution, it is set to the appropriate level by codec before being output.
- The ALAC decoder is distributed under the Apache License, Version 2.0 (<http://www.apache.org/licenses/LICENSE-2.0>)

Specifications

Wireless LAN

Network type:	Conforming to IEEE 802.11a/b/g/n/ac
Used frequency range:	2.4 GHz, 5 GHz

General

Operating temperature:	41 °F - 95 °F (5 °C - 35 °C)
Power supply:	AC 100 – 240 V, 50/60 Hz (for Europe model) AC 100 – 120 V, 50/60 Hz (for North America model)
Power consumption:	37 W
Power consumption in Quick Start Mode:	2.2 W (Wi-Fi 2.4 GHz) 2.2 W (Wi-Fi 5 GHz) 1.9 W (Ethernet) 2.3 W (USB with Wi-Fi) 1.8 W (Bluetooth)
Power consumption in Deep Standby Mode:	0.4 W
Max Analog Input:	2 Vrms

Dimensions

Unit : in. (mm)

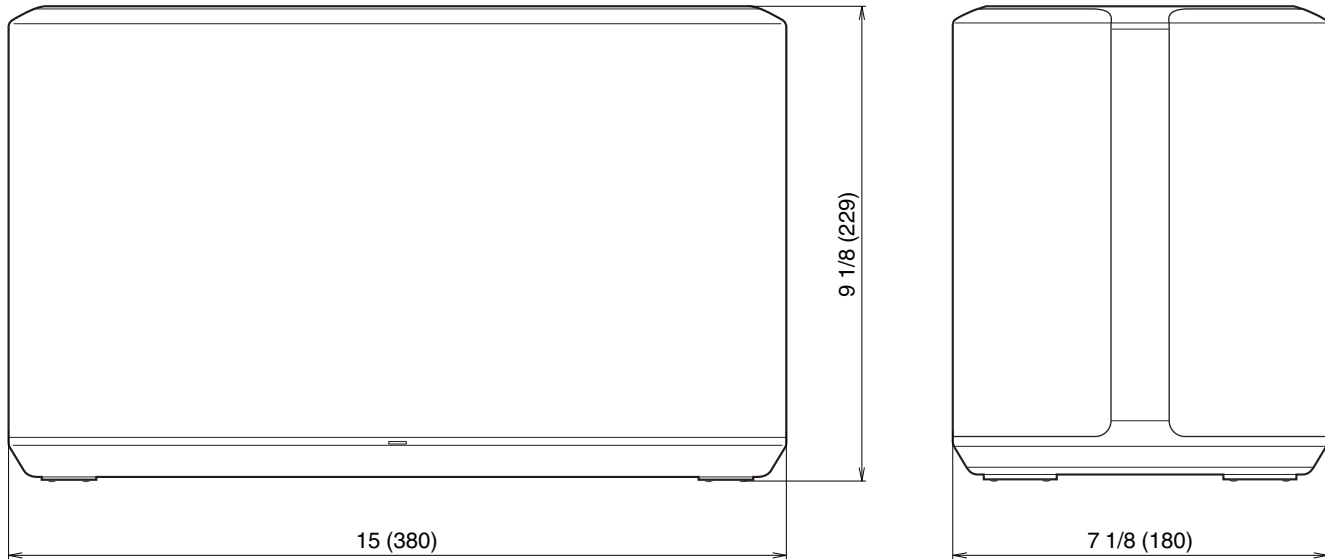

Weight : 14 lbs 12 oz (6.7 kg)

For the purpose of improvement, the specifications and design are subject to change without notice.

Information

Trademarks



Google Play and the Google Play logo are trademarks of Google LLC.



Apple, the Apple logo, iPhone, and iPad are trademarks of Apple Inc., registered in the U.S. and other countries and regions. App Store is a service mark of Apple Inc.



Wi-Fi Protected Setup™ logo is trademark of Wi-Fi Alliance.



The Bluetooth® word mark and logos are registered trademarks owned by the Bluetooth SIG, Inc. and any use of such marks by D&M Holdings Inc. is under license. Other trademarks and trade names are those of their respective owners.



Apple, AirPlay, iPad, iPad Air, iPad Pro and iPhone are trademarks of Apple Inc., registered in the U.S. and other countries.

The trademark "iPhone" is used in Japan with a license from Aiphone K.K.

Use of the Works with Apple badge means that an accessory has been designed to work specifically with the technology identified in the badge and has been certified by the developer to meet Apple performance standards.

License

■ License information for the software used in the unit

About GPL (GNU-General Public License), LGPL (GNU Lesser General Public License) License

This product uses GPL/LGPL software and software made by other companies.

After you purchase this product, you may procure, modify or distribute the source code of the GPL/LGPL software that is used in the product.

Denon provides the source code based on the GPL and LGPL licenses at the actual cost upon your request to our customer service center. However, note that we make no guarantees concerning the source code. Please also understand that we do not offer support for the contents of the source code.

This section describes software license used for this unit. To maintain the correct content, the original (English) is used.

□ GPL

Open Source Used	Version
bridge-utils	1.6
busybox	1.27.2
ebtables	2.0.10-4
Linux kernel	4.4.22
mtd-utils	2.0.2
ntfs-3g_ntfsprogs	2017.3.23
u-boot	2018.07
cifs-utils	6.7
wireless-tools	2.9
ffmpeg	3.4.4

□ LGPL

Open Source Used	Version
ffmpeg	3.4.4
libmms	0.6.4
taglib	1.11.1
libglib2	2.54.2
libnl	3.4.0
glibc	2.28
glib	2-2.54.2
ntfs-3g_ntfsprogs	2017.3.23

❑ Mbed TLS-2.7.5

Apache License

Version 2.0, January 2004

<http://www.apache.org/licenses/>

TERMS AND CONDITIONS FOR USE, REPRODUCTION, AND DISTRIBUTION

1. Definitions.

"License" shall mean the terms and conditions for use, reproduction, and distribution as defined by Sections 1 through 9 of this document.

"Licensor" shall mean the copyright owner or entity authorized by the copyright owner that is granting the License.

"Legal Entity" shall mean the union of the acting entity and all other entities that control, are controlled by, or are under common control with that entity. For the purposes of this definition, "control" means (i) the power, direct or indirect, to cause the direction or management of such entity, whether by contract or otherwise, or (ii) ownership of fifty percent (50 %) or more of the outstanding shares, or (iii) beneficial ownership of such entity.

"You" (or "Your") shall mean an individual or Legal Entity exercising permissions granted by this License.

"Source" form shall mean the preferred form for making modifications, including but not limited to software source code, documentation source, and configuration files.

"Object" form shall mean any form resulting from mechanical transformation or translation of a Source form, including but not limited to compiled object code, generated documentation, and conversions to other media types.

"Work" shall mean the work of authorship, whether in Source or Object form, made available under the License, as indicated by a copyright notice that is included in or attached to the work (an example is provided in the Appendix below).

"Derivative Works" shall mean any work, whether in Source or Object form, that is based on (or derived from) the Work and for which the editorial revisions, annotations, elaborations, or other modifications represent, as a whole, an original work of authorship. For the purposes of this License, Derivative Works shall not include works that remain separable from, or merely link (or bind by name) to the interfaces of, the Work and Derivative Works thereof.

"Contribution" shall mean any work of authorship, including the original version of the Work and any modifications or additions to that Work or Derivative Works thereof, that is intentionally submitted to Licensor for inclusion in the Work by the copyright owner or by an individual or Legal Entity authorized to submit on behalf of the copyright owner. For the purposes of this definition, "submitted" means any form of electronic, verbal, or written communication sent to the Licensor or its representatives, including but not limited to communication on electronic mailing lists, source code control systems, and issue tracking systems that are managed by, or on behalf of, the Licensor for the purpose of discussing and improving the Work, but excluding communication that is conspicuously marked or otherwise designated in writing by the copyright owner as "Not a Contribution."

"Contributor" shall mean Licensor and any individual or Legal Entity on behalf of whom a Contribution has been received by Licensor and subsequently incorporated within the Work.

2. **Grant of Copyright License.** Subject to the terms and conditions of this License, each Contributor hereby grants to You a perpetual, worldwide, non-exclusive, no-charge, royalty-free, irrevocable copyright license to reproduce, prepare Derivative Works of, publicly display, publicly perform, sublicense, and distribute the Work and such Derivative Works in Source or Object form.
3. **Grant of Patent License.** Subject to the terms and conditions of this License, each Contributor hereby grants to You a perpetual, worldwide, non-exclusive, no-charge, royalty-free, irrevocable (except as stated in this section) patent license to make, have made, use, offer to sell, sell, import, and otherwise transfer the Work, where such license applies only to those patent claims licensable by such Contributor that are necessarily infringed by their Contribution(s) alone or by combination of their Contribution(s) with the Work to which such Contribution(s) was submitted. If You institute patent litigation against any entity (including a cross-claim or counterclaim in a lawsuit) alleging that the Work or a Contribution incorporated within the Work constitutes direct or contributory patent infringement, then any patent licenses granted to You under this License for that Work shall terminate as of the date such litigation is filed.
4. **Redistribution.** You may reproduce and distribute copies of the Work or Derivative Works thereof in any medium, with or without modifications, and in Source or Object form, provided that You meet the following conditions:
 - (a) You must give any other recipients of the Work or Derivative Works a copy of this License; and
 - (b) You must cause any modified files to carry prominent notices stating that You changed the files; and
 - (c) You must retain, in the Source form of any Derivative Works that You distribute, all copyright, patent, trademark, and attribution notices from the Source form of the Work, excluding those notices that do not pertain to any part of the Derivative Works; and
 - (d) If the Work includes a "NOTICE" text file as part of its distribution, then any Derivative Works that You distribute must include a readable copy of the attribution notices contained within such NOTICE file, excluding those notices that do not pertain to any part of the Derivative Works, in at least one of the following places: within a NOTICE text file distributed as part of the Derivative Works; within the Source form or documentation, if provided along with the Derivative Works; or, within a display generated by the Derivative Works, if and wherever such third-party notices normally appear. The contents of the NOTICE file are for informational purposes only and do not modify the License. You may add Your own attribution notices within Derivative Works that You distribute, alongside or as an addendum to the NOTICE text from the Work, provided that such additional attribution notices cannot be construed as modifying the License.You may add Your own copyright statement to Your modifications and may provide additional or different license terms and conditions for use, reproduction, or distribution of Your modifications, or for any such Derivative Works as a whole, provided Your use, reproduction, and distribution of the Work otherwise complies with the conditions stated in this License.
5. **Submission of Contributions.** Unless You explicitly state otherwise, any Contribution intentionally submitted for inclusion in the Work by You to the Licensor shall be under the terms and conditions of this License, without any additional terms or conditions. Notwithstanding the above, nothing herein shall supersede or modify the terms of any separate license agreement you may have executed with Licensor regarding such Contributions.

6. Trademarks. This License does not grant permission to use the trade names, trademarks, service marks, or product names of the Licensor, except as required for reasonable and customary use in describing the origin of the Work and reproducing the content of the NOTICE file.
7. Disclaimer of Warranty. Unless required by applicable law or agreed to in writing, Licensor provides the Work (and each Contributor provides its Contributions) on an "AS IS" BASIS, WITHOUT WARRANTIES OR CONDITIONS OF ANY KIND, either express or implied, including, without limitation, any warranties or conditions of TITLE, NON-INFRINGEMENT, MERCHANTABILITY, or FITNESS FOR A PARTICULAR PURPOSE. You are solely responsible for determining the appropriateness of using or redistributing the Work and assume any risks associated with Your exercise of permissions under this License.
8. Limitation of Liability. In no event and under no legal theory, whether in tort (including negligence), contract, or otherwise, unless required by applicable law (such as deliberate and grossly negligent acts) or agreed to in writing, shall any Contributor be liable to You for damages, including any direct, indirect, special, incidental, or consequential damages of any character arising as a result of this License or out of the use or inability to use the Work (including but not limited to damages for loss of goodwill, work stoppage, computer failure or malfunction, or any and all other commercial damages or losses), even if such Contributor has been advised of the possibility of such damages.

9. Accepting Warranty or Additional Liability. While redistributing the Work or Derivative Works thereof, You may choose to offer, and charge a fee for, acceptance of support, warranty, indemnity, or other liability obligations and/or rights consistent with this License. However, in accepting such obligations, You may act only on Your own behalf and on Your sole responsibility, not on behalf of any other Contributor, and only if You agree to indemnify, defend, and hold each Contributor harmless for any liability incurred by, or claims asserted against, such Contributor by reason of your accepting any such warranty or additional liability.

END OF TERMS AND CONDITIONS

APPENDIX: How to apply the Apache License to your work.

To apply the Apache License to your work, attach the following boilerplate notice, with the fields enclosed by brackets "[]" replaced with your own identifying information. (Don't include the brackets!) The text should be enclosed in the appropriate comment syntax for the file format. We also recommend that a file or class name and description of purpose be included on the same "printed page" as the copyright notice for easier identification within third-party archives.

Copyright [yyyy] [name of copyright owner]

Licensed under the Apache License, Version 2.0 (the "License"); you may not use this file except in compliance with the License. You may obtain a copy of the License at

<http://www.apache.org/licenses/LICENSE-2.0>

Unless required by applicable law or agreed to in writing, software distributed under the License is distributed on an "AS IS" BASIS, WITHOUT WARRANTIES OR CONDITIONS OF ANY KIND, either express or implied. See the License for the specific language governing permissions and limitations under the License.

❑ mDNSResponder-765.50.9

The majority of the source code in the mDNSResponder project is licensed under the terms of the Apache License, Version 2.0, available from:

<http://www.apache.org/licenses/LICENSE-2.0>

To accommodate license compatibility with the widest possible range of client code licenses, the shared library code, which is linked at runtime into the same address space as the client using it, is licensed under the terms of the "Three-Clause BSD License".

The Linux Name Service Switch code, contributed by National ICT Australia Ltd (NICTA) is licensed under the terms of the NICTA Public Software Licence (which is substantially similar to the "Three-Clause BSD License", with some additional language pertaining to Australian law).

❑ OpenAvnu-2018-07-30

Copyright (c) 2012, Intel Corporation

All rights reserved.

Redistribution and use in source and binary forms, with or without modification, are permitted provided that the following conditions are met:

1. Redistributions of source code must retain the above copyright notice, this list of conditions and the following disclaimer.
2. Redistributions in binary form must reproduce the above copyright notice, this list of conditions and the following disclaimer in the documentation and/or other materials provided with the distribution.
3. Neither the name of the Intel Corporation nor the names of its contributors may be used to endorse or promote products derived from this software without specific prior written permission.

THIS SOFTWARE IS PROVIDED BY THE COPYRIGHT HOLDERS AND CONTRIBUTORS "AS IS" AND ANY EXPRESS OR IMPLIED WARRANTIES, INCLUDING, BUT NOT LIMITED TO, THE IMPLIED WARRANTIES OF MERCHANTABILITY AND FITNESS FOR A PARTICULAR PURPOSE ARE DISCLAIMED. IN NO EVENT SHALL THE COPYRIGHT OWNER OR CONTRIBUTORS BE LIABLE FOR ANY DIRECT, INDIRECT, INCIDENTAL, SPECIAL, EXEMPLARY, OR CONSEQUENTIAL DAMAGES (INCLUDING, BUT NOT LIMITED TO, PROCUREMENT OF SUBSTITUTE GOODS OR SERVICES; LOSS OF USE, DATA, OR PROFITS; OR BUSINESS INTERRUPTION) HOWEVER CAUSED AND ON ANY THEORY OF LIABILITY, WHETHER IN CONTRACT, STRICT LIABILITY, OR TORT (INCLUDING NEGLIGENCE OR OTHERWISE) ARISING IN ANY WAY OUT OF THE USE OF THIS SOFTWARE, EVEN IF ADVISED OF THE POSSIBILITY OF SUCH DAMAGE.

❑ **fmt-5.1.0**

Copyright (c) 2012 - 2016, Victor Zverovich

All rights reserved.

Redistribution and use in source and binary forms, with or without modification, are permitted provided that the following conditions are met:

1. Redistributions of source code must retain the above copyright notice, this list of conditions and the following disclaimer.
2. Redistributions in binary form must reproduce the above copyright notice, this list of conditions and the following disclaimer in the documentation and/or other materials provided with the distribution.

THIS SOFTWARE IS PROVIDED BY THE COPYRIGHT HOLDERS AND CONTRIBUTORS "AS IS" AND ANY EXPRESS OR IMPLIED WARRANTIES, INCLUDING, BUT NOT LIMITED TO, THE IMPLIED WARRANTIES OF MERCHANTABILITY AND FITNESS FOR A PARTICULAR PURPOSE ARE DISCLAIMED. IN NO EVENT SHALL THE COPYRIGHT OWNER OR CONTRIBUTORS BE LIABLE FOR ANY DIRECT, INDIRECT, INCIDENTAL, SPECIAL, EXEMPLARY, OR CONSEQUENTIAL DAMAGES (INCLUDING, BUT NOT LIMITED TO, PROCUREMENT OF SUBSTITUTE GOODS OR SERVICES; LOSS OF USE, DATA, OR PROFITS; OR BUSINESS INTERRUPTION) HOWEVER CAUSED AND ON ANY THEORY OF LIABILITY, WHETHER IN CONTRACT, STRICT LIABILITY, OR TORT (INCLUDING NEGLIGENCE OR OTHERWISE) ARISING IN ANY WAY OUT OF THE USE OF THIS SOFTWARE, EVEN IF ADVISED OF THE POSSIBILITY OF SUCH DAMAGE.

❑ **libtar-1.2.20**

Copyright (c) 1998-2003 University of Illinois Board of Trustees

Copyright (c) 1998-2003 Mark D. Roth

All rights reserved.

Developed by: Campus Information Technologies and Educational Services, University of Illinois at Urbana-Champaign

Permission is hereby granted, free of charge, to any person obtaining a copy of this software and associated documentation files (the "Software"), to deal with the Software without restriction, including without limitation the rights to use, copy, modify, merge, publish, distribute, sublicense, and/or sell copies of the Software, and to permit persons to whom the Software is furnished to do so, subject to the following conditions:

- * Redistributions of source code must retain the above copyright notice, this list of conditions and the following disclaimers.
- * Redistributions in binary form must reproduce the above copyright notice, this list of conditions and the following disclaimers in the documentation and/or other materials provided with the distribution.
- * Neither the names of Campus Information Technologies and Educational Services, University of Illinois at Urbana-Champaign, nor the names of its contributors may be used to endorse or promote products derived from this Software without specific prior written permission.

THE SOFTWARE IS PROVIDED "AS IS", WITHOUT WARRANTY OF ANY KIND, EXPRESS OR IMPLIED, INCLUDING BUT NOT LIMITED TO THE WARRANTIES OF MERCHANTABILITY, FITNESS FOR A PARTICULAR PURPOSE AND NONINFRINGEMENT. IN NO EVENT SHALL THE CONTRIBUTORS OR COPYRIGHT HOLDERS BE LIABLE FOR ANY CLAIM, DAMAGES OR OTHER LIABILITY, WHETHER IN AN ACTION OF CONTRACT, TORT OR OTHERWISE, ARISING FROM, OUT OF OR IN CONNECTION WITH THE SOFTWARE OR THE USE OR OTHER DEALINGS WITH THE SOFTWARE.

❏ ARM Trusted Firmware-1.21

Copyright (c) 2013-2015, ARM Limited and Contributors. All rights reserved.

Redistribution and use in source and binary forms, with or without modification, are permitted provided that the following conditions are met:

- * Redistributions of source code must retain the above copyright notice, this list of conditions and the following disclaimer.
- * Redistributions in binary form must reproduce the above copyright notice, this list of conditions and the following disclaimer in the documentation and/or other materials provided with the distribution.
- * Neither the name of ARM nor the names of its contributors may be used to endorse or promote products derived from this software without specific prior written permission.

THIS SOFTWARE IS PROVIDED BY THE COPYRIGHT HOLDERS AND CONTRIBUTORS "AS IS" AND ANY EXPRESS OR IMPLIED WARRANTIES, INCLUDING, BUT NOT LIMITED TO, THE IMPLIED WARRANTIES OF MERCHANTABILITY AND FITNESS FOR A PARTICULAR PURPOSE ARE DISCLAIMED. IN NO EVENT SHALL THE COPYRIGHT HOLDER OR CONTRIBUTORS BE LIABLE FOR ANY DIRECT, INDIRECT, INCIDENTAL, SPECIAL, EXEMPLARY, OR CONSEQUENTIAL DAMAGES (INCLUDING, BUT NOT LIMITED TO, PROCUREMENT OF SUBSTITUTE GOODS OR SERVICES; LOSS OF USE, DATA, OR PROFITS; OR BUSINESS INTERRUPTION) HOWEVER CAUSED AND ON ANY THEORY OF LIABILITY, WHETHER IN CONTRACT, STRICT LIABILITY, OR TORT (INCLUDING NEGLIGENCE OR OTHERWISE) ARISING IN ANY WAY OUT OF THE USE OF THIS SOFTWARE, EVEN IF ADVISED OF THE POSSIBILITY OF SUCH DAMAGE.

❑ googletest-v1.8.0 Protocol Buffers-v3.6.0

Copyright 2008, Google Inc.
All rights reserved.

Redistribution and use in source and binary forms, with or without modification, are permitted provided that the following conditions are met:

- * Redistributions of source code must retain the above copyright notice, this list of conditions and the following disclaimer.
- * Redistributions in binary form must reproduce the above copyright notice, this list of conditions and the following disclaimer in the documentation and/or other materials provided with the distribution.
- * Neither the name of Google Inc. nor the names of its contributors may be used to endorse or promote products derived from this software without specific prior written permission.

THIS SOFTWARE IS PROVIDED BY THE COPYRIGHT HOLDERS AND CONTRIBUTORS AS IS AND ANY EXPRESS OR IMPLIED WARRANTIES, INCLUDING, BUT NOT LIMITED TO, THE IMPLIED WARRANTIES OF MERCHANTABILITY AND FITNESS FOR A PARTICULAR PURPOSE ARE DISCLAIMED. IN NO EVENT SHALL THE COPYRIGHT OWNER OR CONTRIBUTORS BE LIABLE FOR ANY DIRECT, INDIRECT, INCIDENTAL, SPECIAL, EXEMPLARY, OR CONSEQUENTIAL DAMAGES (INCLUDING, BUT NOT LIMITED TO, PROCUREMENT OF SUBSTITUTE GOODS OR SERVICES; LOSS OF USE, DATA, OR PROFITS; OR BUSINESS INTERRUPTION) HOWEVER CAUSED AND ON ANY THEORY OF LIABILITY, WHETHER IN CONTRACT, STRICT LIABILITY, OR TORT (INCLUDING NEGLIGENCE OR OTHERWISE) ARISING IN ANY WAY OUT OF THE USE OF THIS SOFTWARE, EVEN IF ADVISED OF THE POSSIBILITY OF SUCH DAMAGE.

❑ hostapd-2.6 wpa_supplicant-2.6

Copyright (c) 2002-2016, Jouni Malinen <j@w1.fi> and contributors
All Rights Reserved.

These programs are licensed under the BSD license (the one with advertisement clause removed).

If you are submitting changes to the project, please see CONTRIBUTIONS file for more instructions.

This package may include either wpa_supplicant, hostapd, or both. See README file respective subdirectories (wpa_supplicant/README or hostapd/README) for more details.

Source code files were moved around in v0.6.x releases and compared to earlier releases, the programs are now built by first going to a subdirectory (wpa_supplicant or hostapd) and creating build configuration (.config) and running 'make' there (for Linux/BSD/cygwin builds).

License

This software may be distributed, used, and modified under the terms of BSD license:

Redistribution and use in source and binary forms, with or without modification, are permitted provided that the following conditions are met:

1. Redistributions of source code must retain the above copyright notice, this list of conditions and the following disclaimer.
2. Redistributions in binary form must reproduce the above copyright notice, this list of conditions and the following disclaimer in the documentation and/or other materials provided with the distribution.

- Neither the name(s) of the above-listed copyright holder(s) nor the names of its contributors may be used to endorse or promote products derived from this software without specific prior written permission.

THIS SOFTWARE IS PROVIDED BY THE COPYRIGHT HOLDERS AND CONTRIBUTORS AS IS AND ANY EXPRESS OR IMPLIED WARRANTIES, INCLUDING, BUT NOT LIMITED TO, THE IMPLIED WARRANTIES OF MERCHANTABILITY AND FITNESS FOR A PARTICULAR PURPOSE ARE DISCLAIMED. IN NO EVENT SHALL THE COPYRIGHT OWNER OR CONTRIBUTORS BE LIABLE FOR ANY DIRECT, INDIRECT, INCIDENTAL, SPECIAL, EXEMPLARY, OR CONSEQUENTIAL DAMAGES (INCLUDING, BUT NOT LIMITED TO, PROCUREMENT OF SUBSTITUTE GOODS OR SERVICES; LOSS OF USE, DATA, OR PROFITS; OR BUSINESS INTERRUPTION) HOWEVER CAUSED AND ON ANY THEORY OF LIABILITY, WHETHER IN CONTRACT, STRICT LIABILITY, OR TORT (INCLUDING NEGLIGENCE OR OTHERWISE) ARISING IN ANY WAY OUT OF THE USE OF THIS SOFTWARE, EVEN IF ADVISED OF THE POSSIBILITY OF SUCH DAMAGE.

❏ **libpcap-1.8.1**

License: BSD

Redistribution and use in source and binary forms, with or without modification, are permitted provided that the following conditions are met:

- Redistributions of source code must retain the above copyright notice, this list of conditions and the following disclaimer.
- Redistributions in binary form must reproduce the above copyright notice, this list of conditions and the following disclaimer in the documentation and/or other materials provided with the distribution.
- The names of the authors may not be used to endorse or promote products derived from this software without specific prior written permission.

THIS SOFTWARE IS PROVIDED "AS IS" AND WITHOUT ANY EXPRESS OR IMPLIED WARRANTIES, INCLUDING, WITHOUT LIMITATION, THE IMPLIED WARRANTIES OF MERCHANTABILITY AND FITNESS FOR A PARTICULAR PURPOSE.

❑ PCRE-8.41PCRE LICENCE

PCRE is a library of functions to support regular expressions whose syntax and semantics are as close as possible to those of the Perl 5 language.

Release 8 of PCRE is distributed under the terms of the "BSD" licence, as specified below. The documentation for PCRE, supplied in the "doc" directory, is distributed under the same terms as the software itself. The data in the testdata directory is not copyrighted and is in the public domain.

The basic library functions are written in C and are freestanding. Also included in the distribution is a set of C++ wrapper functions, and a just-in-time compiler that can be used to optimize pattern matching. These are both optional features that can be omitted when the library is built.

THE BASIC LIBRARY FUNCTIONS

Written by: Philip Hazel

Email local part: ph10

Email domain: cam.ac.uk

University of Cambridge Computing Service, Cambridge, England.

Copyright (c) 1997-2017 University of Cambridge

All rights reserved.

PCRE JUST-IN-TIME COMPILATION SUPPORT

Written by: Zoltan Herczeg

Email local part: hzmester

Email domain: freemail.hu

Copyright(c) 2010-2017 Zoltan Herczeg

All rights reserved.

STACK-LESS JUST-IN-TIME COMPILER

Written by: Zoltan Herczeg

Email local part: hzmester

Email domain: freemail.hu

Copyright(c) 2009-2017 Zoltan Herczeg

All rights reserved.

THE C++ WRAPPER FUNCTIONS

Contributed by: Google Inc.

Copyright (c) 2007-2012, Google Inc.

All rights reserved.

THE "BSD" LICENCE

Redistribution and use in source and binary forms, with or without modification, are permitted provided that the following conditions are met:

- * Redistributions of source code must retain the above copyright notice, this list of conditions and the following disclaimer.
- * Redistributions in binary form must reproduce the above copyright notice, this list of conditions and the following disclaimer in the documentation and/or other materials provided with the distribution.
- * Neither the name of the University of Cambridge nor the name of Google Inc. nor the names of their contributors may be used to endorse or promote products derived from this software without specific prior written permission.

THIS SOFTWARE IS PROVIDED BY THE COPYRIGHT HOLDERS AND CONTRIBUTORS "AS IS" AND ANY EXPRESS OR IMPLIED WARRANTIES, INCLUDING, BUT NOT LIMITED TO, THE IMPLIED WARRANTIES OF MERCHANTABILITY AND FITNESS FOR A PARTICULAR PURPOSE ARE DISCLAIMED. IN NO EVENT SHALL THE COPYRIGHT OWNER OR CONTRIBUTORS BE LIABLE FOR ANY DIRECT, INDIRECT, INCIDENTAL, SPECIAL, EXEMPLARY, OR CONSEQUENTIAL DAMAGES (INCLUDING, BUT NOT LIMITED TO, PROCUREMENT OF SUBSTITUTE GOODS OR SERVICES; LOSS OF USE, DATA, OR PROFITS; OR BUSINESS INTERRUPTION) HOWEVER CAUSED AND ON ANY THEORY OF LIABILITY, WHETHER IN CONTRACT, STRICT LIABILITY, OR TORT (INCLUDING NEGLIGENCE OR OTHERWISE) ARISING IN ANY WAY OUT OF THE USE OF THIS SOFTWARE, EVEN IF ADVISED OF THE POSSIBILITY OF SUCH DAMAGE.

End

❑ Boost-1.66.0

Boost Software License - Version 1.0 - August 17th, 2003

Permission is hereby granted, free of charge, to any person or organization obtaining a copy of the software and accompanying documentation covered by this license (the "Software") to use, reproduce, display, distribute, execute, and transmit the Software, and to prepare derivative works of the Software, and to permit third-parties to whom the Software is furnished to do so, all subject to the following:

The copyright notices in the Software and this entire statement, including the above license grant, this restriction and the following disclaimer, must be included in all copies of the Software, in whole or in part, and all derivative works of the Software, unless such copies or derivative works are solely in the form of machine-executable object code generated by a source language processor.

THE SOFTWARE IS PROVIDED "AS IS", WITHOUT WARRANTY OF ANY KIND, EXPRESS OR IMPLIED, INCLUDING BUT NOT LIMITED TO THE WARRANTIES OF MERCHANTABILITY, FITNESS FOR A PARTICULAR PURPOSE, TITLE AND NON-INFRINGEMENT. IN NO EVENT SHALL THE COPYRIGHT HOLDERS OR ANYONE DISTRIBUTING THE SOFTWARE BE LIABLE FOR ANY DAMAGES OR OTHER LIABILITY, WHETHER IN CONTRACT, TORT OR OTHERWISE, ARISING FROM, OUT OF OR IN CONNECTION WITH THE SOFTWARE OR THE USE OR OTHER DEALINGS IN THE SOFTWARE.

❑ libcurl-7.61.1

Copyright (c) 1996 - 2018, Daniel Stenberg, <daniel@haxx.se>, and many contributors, see the THANKS file.

All rights reserved.

Permission to use, copy, modify, and distribute this software for any purpose with or without fee is hereby granted, provided that the above copyright notice and this permission notice appear in all copies.

THE SOFTWARE IS PROVIDED "AS IS", WITHOUT WARRANTY OF ANY KIND, EXPRESS OR IMPLIED, INCLUDING BUT NOT LIMITED TO THE WARRANTIES OF MERCHANTABILITY, FITNESS FOR A PARTICULAR PURPOSE AND NONINFRINGEMENT OF THIRD PARTY RIGHTS. IN NO EVENT SHALL THE AUTHORS OR COPYRIGHT HOLDERS BE LIABLE FOR ANY CLAIM, DAMAGES OR OTHER LIABILITY, WHETHER IN AN ACTION OF CONTRACT, TORT OR OTHERWISE, ARISING FROM, OUT OF OR IN CONNECTION WITH THE SOFTWARE OR THE USE OR OTHER DEALINGS IN THE SOFTWARE.

❑ libjpeg-turbo-1.5.2

libjpeg-turbo is covered by three compatible BSD-style open source licenses:

- The IJG (Independent JPEG Group) License, which is listed in README.iyg

This license applies to the libjpeg API library and associated programs (any code inherited from libjpeg, and any modifications to that code.)

- The Modified (3-clause) BSD License, which is listed below

This license covers the TurboJPEG API library and associated programs.

- The zlib License, which is listed below

This license is a subset of the other two, and it covers the libjpeg-turbo SIMD extensions.

Complying with the libjpeg-turbo Licenses

=====
This section provides a roll-up of the libjpeg-turbo licensing terms, to the best of our understanding.

1. If you are distributing a modified version of the libjpeg-turbo source, then:

1. You cannot alter or remove any existing copyright or license notices from the source.

****Origin****

- Clause 1 of the IJG License

- Clause 1 of the Modified BSD License

- Clauses 1 and 3 of the zlib License

2. You must add your own copyright notice to the header of each source file you modified, so others can tell that you modified that file (if there is not an existing copyright header in that file, then you can simply add a notice stating that you modified the file.)
 - **Origin****
 - Clause 1 of the IJG License
 - Clause 2 of the zlib License
 3. You must include the IJG README file, and you must not alter any of the copyright or license text in that file.
 - **Origin****
 - Clause 1 of the IJG License
 2. If you are distributing only libjpeg-turbo binaries without the source, or if you are distributing an application that statically links with libjpeg-turbo, then:
 1. Your product documentation must include a message stating:

This software is based in part on the work of the Independent JPEG Group.

 - **Origin****
 - Clause 2 of the IJG license
 2. If your binary distribution includes or uses the TurboJPEG API, then your product documentation must include the text of the Modified BSD License.
 - **Origin****
 - Clause 2 of the Modified BSD License
 3. You cannot use the name of the IJG or The libjpeg-turbo Project or the contributors thereof in advertising, publicity, etc.
 - **Origin****
 - IJG License
 - Clause 3 of the Modified BSD License
 4. The IJG and The libjpeg-turbo Project do not warrant libjpeg-turbo to be free of defects, nor do we accept any liability for undesirable consequences resulting from your use of the software.
 - **Origin****
 - IJG License
 - Modified BSD License
 - zlib License
- The Modified (3-clause) BSD License
- =====
- Copyright (C)¥<YEAR¥> ¥<AUTHOR¥>. All Rights Reserved.
- Redistribution and use in source and binary forms, with or without modification, are permitted provided that the following conditions are met:
- Redistributions of source code must retain the above copyright notice, this list of conditions and the following disclaimer.
 - Redistributions in binary form must reproduce the above copyright notice, this list of conditions and the following disclaimer in the documentation and/or other materials provided with the distribution.
 - Neither the name of the libjpeg-turbo Project nor the names of its contributors may be used to endorse or promote products derived from this software without specific prior written permission.

THIS SOFTWARE IS PROVIDED BY THE COPYRIGHT HOLDERS AND CONTRIBUTORS "AS IS", AND ANY EXPRESS OR IMPLIED WARRANTIES, INCLUDING, BUT NOT LIMITED TO, THE IMPLIED WARRANTIES OF MERCHANTABILITY AND FITNESS FOR A PARTICULAR PURPOSE ARE DISCLAIMED. IN NO EVENT SHALL THE COPYRIGHT HOLDERS OR CONTRIBUTORS BE LIABLE FOR ANY DIRECT, INDIRECT, INCIDENTAL, SPECIAL, EXEMPLARY, OR CONSEQUENTIAL DAMAGES (INCLUDING, BUT NOT LIMITED TO, PROCUREMENT OF SUBSTITUTE GOODS OR SERVICES; LOSS OF USE, DATA, OR PROFITS; OR BUSINESS INTERRUPTION) HOWEVER CAUSED AND ON ANY THEORY OF LIABILITY, WHETHER IN CONTRACT, STRICT LIABILITY, OR TORT (INCLUDING NEGLIGENCE OR OTHERWISE) ARISING IN ANY WAY OUT OF THE USE OF THIS SOFTWARE, EVEN IF ADVISED OF THE POSSIBILITY OF SUCH DAMAGE.

The zlib License

=====

Copyright (C) ¥<YEAR¥>, ¥<AUTHOR¥>.

This software is provided 'as-is', without any express or implied warranty. In no event will the authors be held liable for any damages arising from the use of this software.

Permission is granted to anyone to use this software for any purpose, including commercial applications, and to alter it and redistribute it freely, subject to the following restrictions:

1. The origin of this software must not be misrepresented; you must not claim that you wrote the original software. If you use this software in a product, an acknowledgment in the product documentation would be appreciated but is not required.
2. Altered source versions must be plainly marked as such, and must not be misrepresented as being the original software.
3. This notice may not be removed or altered from any source distribution.

❑ iw-4.9

Copyright (c) 2007, 2008 Johannes Berg

Copyright (c) 2007 Andy Lutomirski

Copyright (c) 2007 Mike Kershaw

Copyright (c) 2008-2009 Luis R. Rodriguez

Permission to use, copy, modify, and/or distribute this software for any purpose with or without fee is hereby granted, provided that the above copyright notice and this permission notice appear in all copies.

THE SOFTWARE IS PROVIDED "AS IS" AND THE AUTHOR DISCLAIMS ALL WARRANTIES WITH REGARD TO THIS SOFTWARE INCLUDING ALL IMPLIED WARRANTIES OF MERCHANTABILITY AND FITNESS. IN NO EVENT SHALL THE AUTHOR BE LIABLE FOR ANY SPECIAL, DIRECT, INDIRECT, OR CONSEQUENTIAL DAMAGES OR ANY DAMAGES WHATSOEVER RESULTING FROM LOSS OF USE, DATA OR PROFITS, WHETHER IN AN ACTION OF CONTRACT, NEGLIGENCE OR OTHER TORTIOUS ACTION, ARISING OUT OF OR IN CONNECTION WITH THE USE OR PERFORMANCE OF THIS SOFTWARE.

❑ taglib-1.11.1

MOZILLA PUBLIC LICENSE

Version 1.1

1. Definitions.

1.0.1. "Commercial Use" means distribution or otherwise making the Covered Code available to a third party.

1.1. "Contributor" means each entity that creates or contributes to the creation of Modifications.

1.2. "Contributor Version" means the combination of the Original Code, prior Modifications used by a Contributor, and the Modifications made by that particular Contributor.

1.3. "Covered Code" means the Original Code or Modifications or the combination of the Original Code and Modifications, in each case including portions thereof.

1.4. "Electronic Distribution Mechanism" means a mechanism generally accepted in the software development community for the electronic transfer of data.

1.5. "Executable" means Covered Code in any form other than Source Code.

1.6. "Initial Developer" means the individual or entity identified as the Initial Developer in the Source Code notice required by Exhibit A.

1.7. "Larger Work" means a work which combines Covered Code or portions thereof with code not governed by the terms of this License.

1.8. "License" means this document.

1.8.1. "Licensable" means having the right to grant, to the maximum extent possible, whether at the time of the initial grant or subsequently acquired, any and all of the rights conveyed herein.

1.9. "Modifications" means any addition to or deletion from the substance or structure of either the Original Code or any previous Modifications. When Covered Code is released as a series of files, a Modification is:

A. Any addition to or deletion from the contents of a file containing Original Code or previous Modifications.

B. Any new file that contains any part of the Original Code or previous Modifications.

1.10. "Original Code" means Source Code of computer software code which is described in the Source Code notice required by Exhibit A as Original Code, and which, at the time of its release under this License is not already Covered Code governed by this License.

1.10.1. "Patent Claims" means any patent claim(s), now owned or hereafter acquired, including without limitation, method, process, and apparatus claims, in any patent Licensable by grantor.

1.11. "Source Code" means the preferred form of the Covered Code for making modifications to it, including all modules it contains, plus any associated interface definition files, scripts used to control compilation and installation of an Executable, or source code differential comparisons against either the Original Code or another well known, available Covered Code of the Contributor's choice. The Source Code can be in a compressed or archival form, provided the appropriate decompression or de-archiving software is widely available for no charge.

1.12. "You" (or "Your") means an individual or a legal entity exercising rights under, and complying with all of the terms of, this License or a future version of this License issued under Section 6.1. For legal entities, "You" includes any entity which controls, is controlled by, or is under common control with You. For purposes of this definition, "control" means (a) the power, direct or indirect, to cause the direction or management of such entity, whether by contract or otherwise, or (b) ownership of more than fifty percent (50%) of the outstanding shares or beneficial ownership of such entity.

2. Source Code License.

2.1. The Initial Developer Grant.

The Initial Developer hereby grants You a world-wide, royalty-free, non-exclusive license, subject to third party intellectual property claims:

(a) under intellectual property rights (other than patent or trademark) Licensable by Initial Developer to use, reproduce, modify, display, perform, sublicense and distribute the Original Code (or portions thereof) with or without Modifications, and/or as part of a Larger Work; and

(b) under Patents Claims infringed by the making, using or selling of Original Code, to make, have made, use, practice, sell, and offer for sale, and/or otherwise dispose of the Original Code (or portions thereof).

(c) the licenses granted in this Section 2.1(a) and (b) are effective on the date Initial Developer first distributes Original Code under the terms of this License.

(d) Notwithstanding Section 2.1(b) above, no patent license is granted: 1) for code that You delete from the Original Code; 2) separate from the Original Code; or 3) for infringements caused by: i) the modification of the Original Code or ii) the combination of the Original Code with other software or devices.

2.2. Contributor Grant.

Subject to third party intellectual property claims, each Contributor hereby grants You a world-wide, royalty-free, non-exclusive license

(a) under intellectual property rights (other than patent or trademark) Licensable by Contributor, to use, reproduce, modify, display, perform, sublicense and distribute the Modifications created by such Contributor (or portions thereof) either on an unmodified basis, with other Modifications, as Covered Code and/or as part of a Larger Work; and

(b) under Patent Claims infringed by the making, using, or selling of Modifications made by that Contributor either alone and/or in combination with its Contributor Version (or portions of such combination), to make, use, sell, offer for sale, have made, and/or otherwise dispose of: 1) Modifications made by that Contributor (or portions thereof); and 2) the combination of Modifications made by that Contributor with its Contributor Version (or portions of such combination).

(c) the licenses granted in Sections 2.2(a) and 2.2(b) are effective on the date Contributor first makes Commercial Use of the Covered Code.

(d) Notwithstanding Section 2.2(b) above, no patent license is granted: 1) for any code that Contributor has deleted from the Contributor Version; 2) separate from the Contributor Version; 3) for infringements caused by: i) third party modifications of Contributor Version or ii) the combination of Modifications made by that Contributor with other software (except as part of the Contributor Version) or other devices; or 4) under Patent Claims infringed by Covered Code in the absence of Modifications made by that Contributor.

3. Distribution Obligations.

3.1. Application of License.

The Modifications which You create or to which You contribute are governed by the terms of this License, including without limitation Section 2.2. The Source Code version of Covered Code may be distributed only under the terms of this License or a future version of this License released under Section 6.1, and You must include a copy of this License with every copy of the Source Code You distribute. You may not offer or impose any terms on any Source Code version that alters or restricts the applicable version of this License or the recipients' rights hereunder. However, You may include an additional document offering the additional rights described in Section 3.5.

3.2. Availability of Source Code.

Any Modification which You create or to which You contribute must be made available in Source Code form under the terms of this License either on the same media as an Executable version or via an accepted Electronic Distribution Mechanism to anyone to whom you made an Executable version available; and if made available via Electronic Distribution Mechanism, must remain available for at least twelve (12) months after the date it initially became available, or at least six (6) months after a subsequent version of that particular Modification has been made available to such recipients. You are responsible for ensuring that the Source Code version remains available even if the Electronic Distribution Mechanism is maintained by a third party.

3.3. Description of Modifications.

You must cause all Covered Code to which You contribute to contain a file documenting the changes You made to create that Covered Code and the date of any change. You must include a prominent statement that the Modification is derived, directly or indirectly, from Original Code provided by the Initial Developer and including the name of the Initial Developer in (a) the Source Code, and (b) in any notice in an Executable version or related documentation in which You describe the origin or ownership of the Covered Code.

3.4. Intellectual Property Matters

(a) Third Party Claims.

If Contributor has knowledge that a license under a third party's intellectual property rights is required to exercise the rights granted by such Contributor under Sections 2.1 or 2.2, Contributor must include a text file with the Source Code distribution titled "LEGAL" which describes the claim and the party making the claim in sufficient detail that a recipient will know whom to contact. If Contributor obtains such knowledge after the Modification is made available as described in Section 3.2, Contributor shall promptly modify the LEGAL file in all copies Contributor makes available thereafter and shall take other steps (such as notifying appropriate mailing lists or newsgroups) reasonably calculated to inform those who received the Covered Code that new knowledge has been obtained.

(b) Contributor APIs.

If Contributor's Modifications include an application programming interface and Contributor has knowledge of patent licenses which are reasonably necessary to implement that API, Contributor must also include this information in the LEGAL file.

(c) Representations.

Contributor represents that, except as disclosed pursuant to Section 3.4(a) above, Contributor believes that Contributor's Modifications are Contributor's original creation(s) and/or Contributor has sufficient rights to grant the rights conveyed by this License.

3.5. Required Notices.

You must duplicate the notice in Exhibit A in each file of the Source Code. If it is not possible to put such notice in a particular Source Code file due to its structure, then You must include such notice in a location (such as a relevant directory) where a user would be likely to look for such a notice. If You created one or more Modification(s) You may add your name as a Contributor to the notice described in Exhibit A. You must also duplicate this License in any documentation for the Source Code where You describe recipients' rights or ownership rights relating to Covered Code. You may choose to offer, and to charge a fee for, warranty, support, indemnity or liability obligations to one or more recipients of Covered Code. However, You may do so only on Your own behalf, and not on behalf of the Initial Developer or any Contributor. You must make it absolutely clear than any such warranty, support, indemnity or liability obligation is offered by You alone, and You hereby agree to indemnify the Initial Developer and every Contributor for any liability incurred by the Initial Developer or such Contributor as a result of warranty, support, indemnity or liability terms You offer.

3.6. Distribution of Executable Versions.

You may distribute Covered Code in Executable form only if the requirements of Section 3.1-3.5 have been met for that Covered Code, and if You include a notice stating that the Source Code version of the Covered Code is available under the terms of this License, including a description of how and where You have fulfilled the obligations of Section 3.2. The notice must be conspicuously included in any notice in an Executable version, related documentation or collateral in which You describe recipients' rights relating to the Covered Code. You may distribute the Executable version of Covered Code or ownership rights under a license of Your choice, which may contain terms different from this License, provided that You are in compliance with the terms of this License and that the license for the Executable version does not attempt to limit or alter the recipient's rights in the Source Code version from the rights set forth in this License. If You distribute the Executable version under a different license You must make it absolutely clear that any terms which differ from this License are offered by You alone, not by the Initial Developer or any Contributor. You hereby agree to indemnify the Initial Developer and every Contributor for any liability incurred by the Initial Developer or such Contributor as a result of any such terms You offer.

3.7. Larger Works.

You may create a Larger Work by combining Covered Code with other code not governed by the terms of this License and distribute the Larger Work as a single product. In such a case, You must make sure the requirements of this License are fulfilled for the Covered Code.

4. Inability to Comply Due to Statute or Regulation.

If it is impossible for You to comply with any of the terms of this License with respect to some or all of the Covered Code due to statute, judicial order, or regulation then You must: (a) comply with the terms of this License to the maximum extent possible; and (b) describe the limitations and the code they affect. Such description must be included in the LEGAL file described in Section 3.4 and must be included with all distributions of the Source Code. Except to the extent prohibited by statute or regulation, such description must be sufficiently detailed for a recipient of ordinary skill to be able to understand it.

5. Application of this License.

This License applies to code to which the Initial Developer has attached the notice in Exhibit A and to related Covered Code.

6. Versions of the License.

6.1. New Versions.

Netscape Communications Corporation ("Netscape") may publish revised and/or new versions of the License from time to time. Each version will be given a distinguishing version number.

6.2. Effect of New Versions.

Once Covered Code has been published under a particular version of the License, You may always continue to use it under the terms of that version. You may also choose to use such Covered Code under the terms of any subsequent version of the License published by Netscape. No one other than Netscape has the right to modify the terms applicable to Covered Code created under this License.

6.3. Derivative Works.

If You create or use a modified version of this License (which you may only do in order to apply it to code which is not already Covered Code governed by this License), You must (a) rename Your license so that the phrases "Mozilla", "MOZILLAPL", "MOZPL", "Netscape", "MPL", "NPL" or any confusingly similar phrase do not appear in your license (except to note that your license differs from this License) and (b) otherwise make it clear that Your version of the license contains terms which differ from the Mozilla Public License and Netscape Public License. (Filling in the name of the Initial Developer, Original Code or Contributor in the notice described in Exhibit A shall not of themselves be deemed to be modifications of this License.)

7. DISCLAIMER OF WARRANTY.

COVERED CODE IS PROVIDED UNDER THIS LICENSE ON AN "AS IS" BASIS, WITHOUT WARRANTY OF ANY KIND, EITHER EXPRESSED OR IMPLIED, INCLUDING, WITHOUT LIMITATION, WARRANTIES THAT THE COVERED CODE IS FREE OF DEFECTS, MERCHANTABILITY, FIT FOR A PARTICULAR PURPOSE OR NON-INFRINGEMENT. THE ENTIRE RISK AS TO THE QUALITY AND PERFORMANCE OF THE COVERED CODE IS WITH YOU. SHOULD ANY COVERED CODE PROVE DEFECTIVE IN ANY RESPECT, YOU (NOT THE INITIAL DEVELOPER OR ANY OTHER CONTRIBUTOR) ASSUME THE COST OF ANY NECESSARY SERVICING, REPAIR OR CORRECTION. THIS DISCLAIMER OF WARRANTY CONSTITUTES AN ESSENTIAL PART OF THIS LICENSE. NO USE OF ANY COVERED CODE IS AUTHORIZED HEREUNDER EXCEPT UNDER THIS DISCLAIMER.

8. TERMINATION.

8.1. This License and the rights granted hereunder will terminate automatically if You fail to comply with terms herein and fail to cure such breach within 30 days of becoming aware of the breach. All sublicenses to the Covered Code which are properly granted shall survive any termination of this License. Provisions which, by their nature, must remain in effect beyond the termination of this License shall survive.

8.2. If You initiate litigation by asserting a patent infringement claim (excluding declaratory judgment actions) against Initial Developer or a Contributor (the Initial Developer or Contributor against whom You file such action is referred to as "Participant") alleging that:

(a) such Participant's Contributor Version directly or indirectly infringes any patent, then any and all rights granted by such Participant to You under Sections 2.1 and/or 2.2 of this License shall, upon 60 days notice from Participant terminate prospectively, unless if within 60 days after receipt of notice You either: (i) agree in writing to pay Participant a mutually agreeable reasonable royalty for Your past and future use of Modifications made by such Participant, or (ii) withdraw Your litigation claim with respect to the Contributor Version against such Participant. If within 60 days of notice, a reasonable royalty and payment arrangement are not mutually agreed upon in writing by the parties or the litigation claim is not withdrawn, the rights granted by Participant to You under Sections 2.1 and/or 2.2 automatically terminate at the expiration of the 60 day notice period specified above.

(b) any software, hardware, or device, other than such Participant's Contributor Version, directly or indirectly infringes any patent, then any rights granted to You by such Participant under Sections 2.1(b) and 2.2(b) are revoked effective as of the date You first made, used, sold, distributed, or had made, Modifications made by that Participant.

8.3. If You assert a patent infringement claim against Participant alleging that such Participant's Contributor Version directly or indirectly infringes any patent where such claim is resolved (such as by license or settlement) prior to the initiation of patent infringement litigation, then the reasonable value of the licenses granted by such Participant under Sections 2.1 or 2.2 shall be taken into account in determining the amount or value of any payment or license.

8.4. In the event of termination under Sections 8.1 or 8.2 above, all end user license agreements (excluding distributors and resellers) which have been validly granted by You or any distributor hereunder prior to termination shall survive termination.

9. LIMITATION OF LIABILITY.

UNDER NO CIRCUMSTANCES AND UNDER NO LEGAL THEORY, WHETHER TORT (INCLUDING NEGLIGENCE), CONTRACT, OR OTHERWISE, SHALL YOU, THE INITIAL DEVELOPER, ANY OTHER CONTRIBUTOR, OR ANY DISTRIBUTOR OF COVERED CODE, OR ANY SUPPLIER OF ANY OF SUCH PARTIES, BE LIABLE TO ANY PERSON FOR ANY INDIRECT, SPECIAL, INCIDENTAL, OR CONSEQUENTIAL DAMAGES OF ANY CHARACTER INCLUDING, WITHOUT LIMITATION, DAMAGES FOR LOSS OF GOODWILL, WORK STOPPAGE, COMPUTER FAILURE OR MALFUNCTION, OR ANY AND ALL OTHER COMMERCIAL DAMAGES OR LOSSES, EVEN IF SUCH PARTY SHALL HAVE BEEN INFORMED OF THE POSSIBILITY OF SUCH DAMAGES. THIS LIMITATION OF LIABILITY SHALL NOT APPLY TO LIABILITY FOR DEATH OR PERSONAL INJURY RESULTING FROM SUCH PARTY'S NEGLIGENCE TO THE EXTENT APPLICABLE LAW PROHIBITS SUCH LIMITATION. SOME JURISDICTIONS DO NOT ALLOW THE EXCLUSION OR LIMITATION OF INCIDENTAL OR CONSEQUENTIAL DAMAGES, SO THIS EXCLUSION AND LIMITATION MAY NOT APPLY TO YOU.

10. U.S. GOVERNMENT END USERS.

The Covered Code is a "commercial item," as that term is defined in 48 C.F.R. 2.101 (Oct. 1995), consisting of "commercial computer software" and "commercial computer software documentation," as such terms are used in 48 C.F.R. 12.212 (Sept. 1995). Consistent with 48 C.F.R. 12.212 and 48 C.F.R. 227.7202-1 through 227.7202-4 (June 1995), all U.S. Government End Users acquire Covered Code with only those rights set forth herein.

11. MISCELLANEOUS.

This License represents the complete agreement concerning subject matter hereof. If any provision of this License is held to be unenforceable, such provision shall be reformed only to the extent necessary to make it enforceable. This License shall be governed by California law provisions (except to the extent applicable law, if any, provides otherwise), excluding its conflict-of-law provisions. With respect to disputes in which at least one party is a citizen of, or an entity chartered or registered to do business in the United States of America, any litigation relating to this License shall be subject to the jurisdiction of the Federal Courts of the Northern District of California, with venue lying in Santa Clara County, California, with the losing party responsible for costs, including without limitation, court costs and reasonable attorneys' fees and expenses. The application of the United Nations Convention on Contracts for the International Sale of Goods is expressly excluded. Any law or regulation which provides that the language of a contract shall be construed against the drafter shall not apply to this License.

12. RESPONSIBILITY FOR CLAIMS.

As between Initial Developer and the Contributors, each party is responsible for claims and damages arising, directly or indirectly, out of its utilization of rights under this License and You agree to work with Initial Developer and Contributors to distribute such responsibility on an equitable basis. Nothing herein is intended or shall be deemed to constitute any admission of liability.

13. MULTIPLE-LICENSED CODE.

Initial Developer may designate portions of the Covered Code as "Multiple-Licensed". "Multiple-Licensed" means that the Initial Developer permits you to utilize portions of the Covered Code under Your choice of the NPL or the alternative licenses, if any, specified by the Initial Developer in the file described in Exhibit A.

EXHIBIT A -Mozilla Public License.

"The contents of this file are subject to the Mozilla Public License Version 1.1 (the "License"); you may not use this file except in compliance with the License. You may obtain a copy of the License at <http://www.mozilla.org/MPL/>

Software distributed under the License is distributed on an "AS IS" basis, WITHOUT WARRANTY OF ANY KIND, either express or implied. See the License for the specific language governing rights and limitations under the License.

The Original Code is _____.

The Initial Developer of the Original Code is _____.

Portions created by _____ are Copyright (C) _____ . All Rights Reserved.

Contributor(s): _____.

Alternatively, the contents of this file may be used under the terms of the _____ license (the "[] License"), in which case the provisions of [] License are applicable instead of those above. If you wish to allow use of your version of this file only under the terms of the [] License and not to allow others to use your version of this file under the MPL, indicate your decision by deleting the provisions above and replace them with the notice and other provisions required by the [] License. If you do not delete the provisions above, a recipient may use your version of this file under either the MPL or the [] License."

[NOTE: The text of this Exhibit A may differ slightly from the text of the notices in the Source Code files of the Original Code. You should use the text of this Exhibit A rather than the text found in the Original Code Source Code for Your Modifications.]

❏ Jansson-2.1

Copyright (c) 2009-2016 Petri Lehtinen <petri@digip.org>

Permission is hereby granted, free of charge, to any person obtaining a copy of this software and associated documentation files (the "Software"), to deal in the Software without restriction, including without limitation the rights to use, copy, modify, merge, publish, distribute, sublicense, and/or sell copies of the Software, and to permit persons to whom the Software is furnished to do so, subject to the following conditions:

The above copyright notice and this permission notice shall be included in all copies or substantial portions of the Software.

THE SOFTWARE IS PROVIDED "AS IS", WITHOUT WARRANTY OF ANY KIND, EXPRESS OR IMPLIED, INCLUDING BUT NOT LIMITED TO THE WARRANTIES OF MERCHANTABILITY, FITNESS FOR A PARTICULAR PURPOSE AND NONINFRINGEMENT. IN NO EVENT SHALL THE AUTHORS OR COPYRIGHT HOLDERS BE LIABLE FOR ANY CLAIM, DAMAGES OR OTHER LIABILITY, WHETHER IN AN ACTION OF CONTRACT, TORT OR OTHERWISE, ARISING FROM, OUT OF OR IN CONNECTION WITH THE SOFTWARE OR THE USE OR OTHER DEALINGS IN THE SOFTWARE.

❑ libffi-3.2.1

libffi - Copyright (c) 1996-2014 Anthony Green, Red Hat, Inc and others.

See source files for details.

Permission is hereby granted, free of charge, to any person obtaining a copy of this software and associated documentation files (the "Software"), to deal in the Software without restriction, including without limitation the rights to use, copy, modify, merge, publish, distribute, sublicense, and/or sell copies of the Software, and to permit persons to whom the Software is furnished to do so, subject to the following conditions:

The above copyright notice and this permission notice shall be included in all copies or substantial portions of the Software.

THE SOFTWARE IS PROVIDED "AS IS", WITHOUT WARRANTY OF ANY KIND, EXPRESS OR IMPLIED, INCLUDING BUT NOT LIMITED TO THE WARRANTIES OF MERCHANTABILITY, FITNESS FOR A PARTICULAR PURPOSE AND NONINFRINGEMENT. IN NO EVENT SHALL THE AUTHORS OR COPYRIGHT HOLDERS BE LIABLE FOR ANY CLAIM, DAMAGES OR OTHER LIABILITY, WHETHER IN AN ACTION OF CONTRACT, TORT OR OTHERWISE, ARISING FROM, OUT OF OR IN CONNECTION WITH THE SOFTWARE OR THE USE OR OTHER DEALINGS IN THE SOFTWARE.

❑ libunwind-1.2.1

Copyright (c) 2002 Hewlett-Packard Co.

Permission is hereby granted, free of charge, to any person obtaining a copy of this software and associated documentation files (the Software), to deal in the Software without restriction, including without limitation the rights to use, copy, modify, merge, publish, distribute, sublicense, and/or sell copies of the Software, and to permit persons to whom the Software is furnished to do so, subject to the following conditions:

The above copyright notice and this permission notice shall be included in all copies or substantial portions of the Software.

THE SOFTWARE IS PROVIDED "AS IS", WITHOUT WARRANTY OF ANY KIND, EXPRESS OR IMPLIED, INCLUDING BUT NOT LIMITED TO THE WARRANTIES OF MERCHANTABILITY, FITNESS FOR A PARTICULAR PURPOSE AND NONINFRINGEMENT. IN NO EVENT SHALL THE AUTHORS OR COPYRIGHT HOLDERS BE LIABLE FOR ANY CLAIM, DAMAGES OR OTHER LIABILITY, WHETHER IN AN ACTION OF CONTRACT, TORT OR OTHERWISE, ARISING FROM, OUT OF OR IN CONNECTION WITH THE SOFTWARE OR THE USE OR OTHER DEALINGS IN THE SOFTWARE. SOFTWARE OR THE USE OR OTHER DEALINGS IN THE SOFTWARE.

❑ Dropbear-2018.76

The majority of code is written by Matt Johnston, under the license below.

Portions of the client-mode work are (c) 2004 Mihnea Stoenescu, under the same license:

Copyright (c) 2002-2015 Matt Johnston

Portions copyright (c) 2004 Mihnea Stoenescu

All rights reserved.

Permission is hereby granted, free of charge, to any person obtaining a copy of this software and associated documentation files (the "Software"), to deal in the Software without restriction, including without limitation the rights to use, copy, modify, merge, publish, distribute, sublicense, and/or sell copies of the Software, and to permit persons to whom the Software is furnished to do so, subject to the following conditions:

The above copyright notice and this permission notice shall be included in all copies or substantial portions of the Software.

THE SOFTWARE IS PROVIDED "AS IS", WITHOUT WARRANTY OF ANY KIND, EXPRESS OR IMPLIED, INCLUDING BUT NOT LIMITED TO THE WARRANTIES OF MERCHANTABILITY, FITNESS FOR A PARTICULAR PURPOSE AND NONINFRINGEMENT. IN NO EVENT SHALL THE AUTHORS OR COPYRIGHT HOLDERS BE LIABLE FOR ANY CLAIM, DAMAGES OR OTHER LIABILITY, WHETHER IN AN ACTION OF CONTRACT, TORT OR OTHERWISE, ARISING FROM, OUT OF OR IN CONNECTION WITH THE SOFTWARE OR THE USE OR OTHER DEALINGS IN THE SOFTWARE.

=====

LibTomCrypt and LibTomMath are written by Tom St Denis, and are Public Domain.

=====

sshpty.c is taken from OpenSSH 3.5p1,

Copyright (c) 1995 Tatu Ylonen <tylo@cs.hut.fi>, Espoo, Finland

All rights reserved

"As far as I am concerned, the code I have written for this software can be used freely for any purpose. Any derived versions of this software must be clearly marked as such, and if the derived work is incompatible with the protocol description in the RFC file, it must be called by a name other than "ssh" or "Secure Shell". "

=====

loginrec.c

loginrec.h

atomicio.h

atomicio.c

and strlcat() (included in util.c) are from OpenSSH 3.6.1p2, and are licensed under the 2 point BSD license.

loginrec is written primarily by Andre Lucas, atomicio.c by Theo de Raadt.

strlcat() is (c) Todd C. Miller

=====

Import code in keyimport.c is modified from PuTTY's import.c, licensed as follows:

PuTTY is copyright 1997-2003 Simon Tatham.

Portions copyright Robert de Bath, Joris van Rantwijk, Delian Delchev, Andreas Schultz, Jeroen Massar, Wez Furlong, Nicolas Barry, Justin Bradford, and CORE SDI S.A.

Permission is hereby granted, free of charge, to any person obtaining a copy of this software and associated documentation files (the "Software"), to deal in the Software without restriction, including without limitation the rights to use, copy, modify, merge, publish, distribute, sublicense, and/or sell copies of the Software, and to permit persons to whom the Software is furnished to do so, subject to the following conditions:

The above copyright notice and this permission notice shall be included in all copies or substantial portions of the Software.

THE SOFTWARE IS PROVIDED "AS IS", WITHOUT WARRANTY OF ANY KIND, EXPRESS OR IMPLIED, INCLUDING BUT NOT LIMITED TO THE WARRANTIES OF MERCHANTABILITY, FITNESS FOR A PARTICULAR PURPOSE AND NONINFRINGEMENT. IN NO EVENT SHALL THE COPYRIGHT HOLDERS BE LIABLE FOR ANY CLAIM, DAMAGES OR OTHER LIABILITY, WHETHER IN AN ACTION OF CONTRACT, TORT OR OTHERWISE, ARISING FROM, OUT OF OR IN CONNECTION WITH THE SOFTWARE OR THE USE OR OTHER DEALINGS IN THE SOFTWARE.

=====

curve25519-donna:

Copyright 2008, Google Inc.

All rights reserved.

Redistribution and use in source and binary forms, with or without modification, are permitted provided that the following conditions are met:

* Redistributions of source code must retain the above copyright notice, this list of conditions and the following disclaimer.

* Redistributions in binary form must reproduce the above copyright notice, this list of conditions and the following disclaimer in the documentation and/or other materials provided with the distribution.

* Neither the name of Google Inc. nor the names of its contributors may be used to endorse or promote products derived from this software without specific prior written permission.

THIS SOFTWARE IS PROVIDED BY THE COPYRIGHT HOLDERS AND CONTRIBUTORS "AS IS" AND ANY EXPRESS OR IMPLIED WARRANTIES, INCLUDING, BUT NOT LIMITED TO, THE IMPLIED WARRANTIES OF MERCHANTABILITY AND FITNESS FOR A PARTICULAR PURPOSE ARE DISCLAIMED. IN NO EVENT SHALL THE COPYRIGHT OWNER OR CONTRIBUTORS BE LIABLE FOR ANY DIRECT, INDIRECT, INCIDENTAL, SPECIAL, EXEMPLARY, OR CONSEQUENTIAL DAMAGES (INCLUDING, BUT NOT LIMITED TO, PROCUREMENT OF SUBSTITUTE GOODS OR SERVICES; LOSS OF USE, DATA, OR PROFITS; OR BUSINESS INTERRUPTION) HOWEVER CAUSED AND ON ANY THEORY OF LIABILITY, WHETHER IN CONTRACT, STRICT LIABILITY, OR TORT (INCLUDING NEGLIGENCE OR OTHERWISE) ARISING IN ANY WAY OUT OF THE USE OF THIS SOFTWARE, EVEN IF ADVISED OF THE POSSIBILITY OF SUCH DAMAGE.

curve25519-donna: Curve25519 elliptic curve, public key function

<http://code.google.com/p/curve25519-donna/>

Adam Langley <agl@imperialviolet.org>

Derived from public domain C code by Daniel J. Bernstein <djb@cr.yp.to>

More information about curve25519 can be found here

<http://cr.yp.to/ecdh.html>

djb's sample implementation of curve25519 is written in a special assembly language called qasm and uses the floating point registers.

This is, almost, a clean room reimplementation from the curve25519 paper. It uses many of the tricks described therein. Only the crecip function is taken from the sample implementation.

❑ OpenSSL-1.0.2p

The OpenSSL toolkit stays under a double license, i.e. both the conditions of the OpenSSL License and the original SSLeay license apply to the toolkit. See below for the actual license texts. Actually both licenses are BSD-style Open Source licenses. In case of any license issues related to OpenSSL please contact openssl-core@openssl.org.

OpenSSL License

Copyright (c) 1998-2018 The OpenSSL Project. All rights reserved.

Redistribution and use in source and binary forms, with or without modification, are permitted provided that the following conditions are met:

1. Redistributions of source code must retain the above copyright notice, this list of conditions and the following disclaimer.
2. Redistributions in binary form must reproduce the above copyright notice, this list of conditions and the following disclaimer in the documentation and/or other materials provided with the distribution.
3. All advertising materials mentioning features or use of this software must display the following acknowledgment: "This product includes software developed by the OpenSSL Project for use in the OpenSSL Toolkit. (<http://www.openssl.org/>)"
4. The names "OpenSSL Toolkit" and "OpenSSL Project" must not be used to endorse or promote products derived from this software without prior written permission. For written permission, please contact openssl-core@openssl.org.
5. Products derived from this software may not be called "OpenSSL" nor may "OpenSSL" appear in their names without prior written permission of the OpenSSL Project.

6. Redistributions of any form whatsoever must retain the following acknowledgment: "This product includes software developed by the OpenSSL Project for use in the OpenSSL Toolkit (<http://www.openssl.org/>)"

THIS SOFTWARE IS PROVIDED BY THE OPENSSL PROJECT "AS IS" AND ANY EXPRESSED OR IMPLIED WARRANTIES, INCLUDING, BUT NOT LIMITED TO, THE IMPLIED WARRANTIES OF MERCHANTABILITY AND FITNESS FOR A PARTICULAR PURPOSE ARE DISCLAIMED. IN NO EVENT SHALL THE OPENSSL PROJECT OR ITS CONTRIBUTORS BE LIABLE FOR ANY DIRECT, INDIRECT, INCIDENTAL, SPECIAL, EXEMPLARY, OR CONSEQUENTIAL DAMAGES (INCLUDING, BUT NOT LIMITED TO, PROCUREMENT OF SUBSTITUTE GOODS OR SERVICES; LOSS OF USE, DATA, OR PROFITS; OR BUSINESS INTERRUPTION) HOWEVER CAUSED AND ON ANY THEORY OF LIABILITY, WHETHER IN CONTRACT, STRICT LIABILITY, OR TORT (INCLUDING NEGLIGENCE OR OTHERWISE) ARISING IN ANY WAY OUT OF THE USE OF THIS SOFTWARE, EVEN IF ADVISED OF THE POSSIBILITY OF SUCH DAMAGE.

This product includes cryptographic software written by Eric Young (ey@cryptsoft.com). This product includes software written by Tim Hudson (tjh@cryptsoft.com).

Original SSLeay License

Copyright (C) 1995-1998 Eric Young (ey@cryptsoft.com)

All rights reserved.

This package is an SSL implementation written by Eric Young (ey@cryptsoft.com).

The implementation was written so as to conform with Netscapes SSL.

This library is free for commercial and non-commercial use as long as the following conditions are adhered to. The following conditions apply to all code found in this distribution, be it the RC4, RSA, lhash, DES, etc., code; not just the SSL code. The SSL documentation included with this distribution is covered by the same copyright terms except that the holder is Tim Hudson (tjh@cryptsoft.com).

Copyright remains Eric Young's, and as such any Copyright notices in the code are not to be removed. If this package is used in a product, Eric Young should be given attribution as the author of the parts of the library used. This can be in the form of a textual message at program startup or in documentation (online or textual) provided with the package.

Redistribution and use in source and binary forms, with or without modification, are permitted provided that the following conditions are met:

1. Redistributions of source code must retain the copyright notice, this list of conditions and the following disclaimer.
2. Redistributions in binary form must reproduce the above copyright notice, this list of conditions and the following disclaimer in the documentation and/or other materials provided with the distribution.
3. All advertising materials mentioning features or use of this software must display the following acknowledgement: "This product includes cryptographic software written by Eric Young (eay@cryptsoft.com)" The word 'cryptographic' can be left out if the routines from the library being used are not cryptographic related :-).
4. If you include any Windows specific code (or a derivative thereof) from the apps directory (application code) you must include an acknowledgement: "This product includes software written by Tim Hudson (tjh@cryptsoft.com)"

THIS SOFTWARE IS PROVIDED BY ERIC YOUNG "AS IS" AND ANY EXPRESS OR IMPLIED WARRANTIES, INCLUDING, BUT NOT LIMITED TO, THE IMPLIED WARRANTIES OF MERCHANTABILITY AND FITNESS FOR A PARTICULAR PURPOSE ARE DISCLAIMED. IN NO EVENT SHALL THE AUTHOR OR CONTRIBUTORS BE LIABLE FOR ANY DIRECT, INDIRECT, INCIDENTAL, SPECIAL, EXEMPLARY, OR CONSEQUENTIAL DAMAGES (INCLUDING, BUT NOT LIMITED TO, PROCUREMENT OF SUBSTITUTE GOODS OR SERVICES; LOSS OF USE, DATA, OR PROFITS; OR BUSINESS INTERRUPTION) HOWEVER CAUSED AND ON ANY THEORY OF LIABILITY, WHETHER IN CONTRACT, STRICT LIABILITY, OR TORT (INCLUDING NEGLIGENCE OR OTHERWISE) ARISING IN ANY WAY OUT OF THE USE OF THIS SOFTWARE, EVEN IF ADVISED OF THE POSSIBILITY OF SUCH DAMAGE.

The licence and distribution terms for any publically available version or derivative of this code cannot be changed. i.e. this code cannot simply be copied and put under another distribution licence [including the GNU Public Licence.]

❑ SQLite-3.21.0

SQLite Is Public Domain

SQLite is in the Public Domain

All of the code and documentation in SQLite has been dedicated to the public domain by the authors. All code authors, and representatives of the companies they work for, have signed affidavits dedicating their contributions to the public domain and originals of those signed affidavits are stored in a firesafe at the main offices of Hwaci. Anyone is free to copy, modify, publish, use, compile, sell, or distribute the original SQLite code, either in source code form or as a compiled binary, for any purpose, commercial or non-commercial, and by any means.

The previous paragraph applies to the deliverable code and documentation in SQLite - those parts of the SQLite library that you actually bundle and ship with a larger application. Some scripts used as part of the build process (for example the "configure" scripts generated by autoconf) might fall under other open-source licenses. Nothing from these build scripts ever reaches the final deliverable SQLite library, however, and so the licenses associated with those scripts should not be a factor in assessing your rights to copy and use the SQLite library.

All of the deliverable code in SQLite has been written from scratch. No code has been taken from other projects or from the open internet. Every line of code can be traced back to its original author, and all of those authors have public domain dedications on file. So the SQLite code base is clean and is uncontaminated with licensed code from other projects.

❑ zlib-1.2.11

Copyright notice:

(C) 1995-2017 Jean-loup Gailly and Mark Adler

This software is provided 'as-is', without any express or implied warranty. In no event will the authors be held liable for any damages arising from the use of this software.

Permission is granted to anyone to use this software for any purpose, including commercial applications, and to alter it and redistribute it freely, subject to the following restrictions:

1. The origin of this software must not be misrepresented; you must not claim that you wrote the original software. If you use this software in a product, an acknowledgment in the product documentation would be appreciated but is not required.
2. Altered source versions must be plainly marked as such, and must not be misrepresented as being the original software.
3. This notice may not be removed or altered from any source distribution.

Jean-loup Gailly Mark Adler

jloup@gzip.org madler@alumni.caltech.edu

If you use the zlib library in a product, we would appreciate *not* receiving lengthy legal documents to sign. The sources are provided for free but without warranty of any kind. The library has been entirely written by Jean-loup Gailly and Mark Adler; it does not include third-party code.

If you redistribute modified sources, we would appreciate that you include in the file ChangeLog history information documenting your changes. Please read the FAQ for more information on the distribution of modified source versions.

❑ e2fsprogs-libs-1.45.4/lib/uuid

Redistribution and use in source and binary forms, with or without modification, are permitted provided that the following conditions are met:

1. Redistributions of source code must retain the above copyright notice, this list of conditions and the following disclaimer.
2. Redistributions in binary form must reproduce the above copyright notice, this list of conditions and the following disclaimer in the documentation and/or other materials provided with the distribution.

THIS SOFTWARE IS PROVIDED BY THE COPYRIGHT HOLDERS AND CONTRIBUTORS "AS IS" AND ANY EXPRESS OR IMPLIED WARRANTIES, INCLUDING, BUT NOT LIMITED TO, THE IMPLIED WARRANTIES OF MERCHANTABILITY AND FITNESS FOR A PARTICULAR PURPOSE ARE DISCLAIMED. IN NO EVENT SHALL THE COPYRIGHT HOLDER OR CONTRIBUTORS BE LIABLE FOR ANY DIRECT, INDIRECT, INCIDENTAL, SPECIAL, EXEMPLARY, OR CONSEQUENTIAL DAMAGES (INCLUDING, BUT NOT LIMITED TO, PROCUREMENT OF SUBSTITUTE GOODS OR SERVICES; LOSS OF USE, DATA, OR PROFITS; OR BUSINESS INTERRUPTION) HOWEVER CAUSED AND ON ANY THEORY OF LIABILITY, WHETHER IN CONTRACT, STRICT LIABILITY, OR TORT (INCLUDING NEGLIGENCE OR OTHERWISE) ARISING IN ANY WAY OUT OF THE USE OF THIS SOFTWARE, EVEN IF ADVISED OF THE POSSIBILITY OF SUCH DAMAGE.

❑ Expat-2.2.5

Copyright (c) 1998-2000 Thai Open Source Software Center Ltd and Clark Cooper

Copyright (c) 2001-2017 Expat maintainers

Permission is hereby granted, free of charge, to any person obtaining a copy of this software and associated documentation files (the Software), to deal in the Software without restriction, including without limitation the rights to use, copy, modify, merge, publish, distribute, sublicense, and/or sell copies of the Software, and to permit persons to whom the Software is furnished to do so, subject to the following conditions:

The above copyright notice and this permission notice shall be included in all copies or substantial portions of the Software.

THE SOFTWARE IS PROVIDED "AS IS", WITHOUT WARRANTY OF ANY KIND, EXPRESS OR IMPLIED, INCLUDING BUT NOT LIMITED TO THE WARRANTIES OF MERCHANTABILITY, FITNESS FOR A PARTICULAR PURPOSE AND NONINFRINGEMENT. IN NO EVENT SHALL THE AUTHORS OR COPYRIGHT HOLDERS BE LIABLE FOR ANY CLAIM, DAMAGES OR OTHER LIABILITY, WHETHER IN AN ACTION OF CONTRACT, TORT OR OTHERWISE, ARISING FROM, OUT OF OR IN CONNECTION WITH THE SOFTWARE OR THE USE OR OTHER DEALINGS IN THE SOFTWARE.

❑ getopt-1.29

Copyright (c) 1987, 1993, 1994

The Regents of the University of California. All rights reserved.

Redistribution and use in source and binary forms, with or without modification, are permitted provided that the following conditions are met:

1. Redistributions of source code must retain the above copyright notice, this list of conditions and the following disclaimer.
2. Redistributions in binary form must reproduce the above copyright notice, this list of conditions and the following disclaimer in the documentation and/or other materials provided with the distribution.
3. Neither the name of the University nor the names of its contributors may be used to endorse or promote products derived from this software without specific prior written permission.

THIS SOFTWARE IS PROVIDED BY THE REGENTS AND CONTRIBUTORS "AS IS" AND ANY EXPRESS OR IMPLIED WARRANTIES, INCLUDING, BUT NOT LIMITED TO, THE IMPLIED WARRANTIES OF MERCHANTABILITY AND FITNESS FOR A PARTICULAR PURPOSE ARE DISCLAIMED. IN NO EVENT SHALL THE REGENTS OR CONTRIBUTORS BE LIABLE FOR ANY DIRECT, INDIRECT, INCIDENTAL, SPECIAL, EXEMPLARY, OR CONSEQUENTIAL DAMAGES (INCLUDING, BUT NOT LIMITED TO, PROCUREMENT OF SUBSTITUTE GOODS OR SERVICES; LOSS OF USE, DATA, OR PROFITS; OR BUSINESS INTERRUPTION) HOWEVER CAUSED AND ON ANY THEORY OF LIABILITY, WHETHER IN CONTRACT, STRICT LIABILITY, OR TORT (INCLUDING NEGLIGENCE OR OTHERWISE) ARISING IN ANY WAY OUT OF THE USE OF THIS SOFTWARE, EVEN IF ADVISED OF THE POSSIBILITY OF SUCH DAMAGE.

❑ jQuery-1.6.1

Copyright 2014 jQuery Foundation and other contributors

<http://jquery.com/>

Permission is hereby granted, free of charge, to any person obtaining a copy of this software and associated documentation files (the Software), to deal in the Software without restriction, including without limitation the rights to use, copy, modify, merge, publish, distribute, sublicense, and/or sell copies of the Software, and to permit persons to whom the Software is furnished to do so, subject to the following conditions:

The above copyright notice and this permission notice shall be included in all copies or substantial portions of the Software.

THE SOFTWARE IS PROVIDED "AS IS", WITHOUT WARRANTY OF ANY KIND, EXPRESS OR IMPLIED, INCLUDING BUT NOT LIMITED TO THE WARRANTIES OF MERCHANTABILITY, FITNESS FOR A PARTICULAR PURPOSE AND NONINFRINGEMENT. IN NO EVENT SHALL THE AUTHORS OR COPYRIGHT HOLDERS BE LIABLE FOR ANY CLAIM, DAMAGES OR OTHER LIABILITY, WHETHER IN AN ACTION OF CONTRACT, TORT OR OTHERWISE, ARISING FROM, OUT OF OR IN CONNECTION WITH THE SOFTWARE OR THE USE OR OTHER DEALINGS IN THE SOFTWARE.

❑ LK embedded kernel

Copyright (c) 2008-2015 Travis Geiselbrecht

Permission is hereby granted, free of charge, to any person obtaining a copy of this software and associated documentation files (the "Software"), to deal in the Software without restriction, including without limitation the rights to use, copy, modify, merge, publish, distribute, sublicense, and/or sell copies of the Software, and to permit persons to whom the Software is furnished to do so, subject to the following conditions:

The above copyright notice and this permission notice shall be included in all copies or substantial portions of the Software.

THE SOFTWARE IS PROVIDED "AS IS", WITHOUT WARRANTY OF ANY KIND, EXPRESS OR IMPLIED, INCLUDING BUT NOT LIMITED TO THE WARRANTIES OF MERCHANTABILITY, FITNESS FOR A PARTICULAR PURPOSE AND NONINFRINGEMENT. IN NO EVENT SHALL THE AUTHORS OR COPYRIGHT HOLDERS BE LIABLE FOR ANY CLAIM, DAMAGES OR OTHER LIABILITY, WHETHER IN AN ACTION OF CONTRACT, TORT OR OTHERWISE, ARISING FROM, OUT OF OR IN CONNECTION WITH THE SOFTWARE OR THE USE OR OTHER DEALINGS IN THE SOFTWARE.

❑ mongoose-2.5

Copyright (c) 2004-2009 Sergey Lyubka

Permission is hereby granted, free of charge, to any person obtaining a copy of this software and associated documentation files (the "Software"), to deal in the Software without restriction, including without limitation the rights to use, copy, modify, merge, publish, distribute, sublicense, and/or sell copies of the Software, and to permit persons to whom the Software is furnished to do so, subject to the following conditions:

The above copyright notice and this permission notice shall be included in all copies or substantial portions of the Software.

THE SOFTWARE IS PROVIDED "AS IS", WITHOUT WARRANTY OF ANY KIND, EXPRESS OR IMPLIED, INCLUDING BUT NOT LIMITED TO THE WARRANTIES OF MERCHANTABILITY, FITNESS FOR A PARTICULAR PURPOSE AND NONINFRINGEMENT. IN NO EVENT SHALL THE AUTHORS OR COPYRIGHT HOLDERS BE LIABLE FOR ANY CLAIM, DAMAGES OR OTHER LIABILITY, WHETHER IN AN ACTION OF CONTRACT, TORT OR OTHERWISE, ARISING FROM, OUT OF OR IN CONNECTION WITH THE SOFTWARE OR THE USE OR OTHER DEALINGS IN THE SOFTWARE.

❑ portmap-6.0

Copyright (c) 1990 The Regents of the University of California.
All rights reserved.

Redistribution and use in source and binary forms, with or without modification, are permitted provided that the following conditions are met:

1. Redistributions of source code must retain the above copyright notice, this list of conditions and the following disclaimer.
2. Redistributions in binary form must reproduce the above copyright notice, this list of conditions and the following disclaimer in the documentation and/or other materials provided with the distribution.
3. All advertising materials mentioning features or use of this software must display the following acknowledgement: This product includes software developed by the University of California, Berkeley and its contributors.
4. Neither the name of the University nor the names of its contributors may be used to endorse or promote products derived from this software without specific prior written permission.

THIS SOFTWARE IS PROVIDED BY THE REGENTS AND CONTRIBUTORS "AS IS" AND ANY EXPRESS OR IMPLIED WARRANTIES, INCLUDING, BUT NOT LIMITED TO, THE IMPLIED WARRANTIES OF MERCHANTABILITY AND FITNESS FOR A PARTICULAR PURPOSE ARE DISCLAIMED. IN NO EVENT SHALL THE REGENTS OR CONTRIBUTORS BE LIABLE FOR ANY DIRECT, INDIRECT, INCIDENTAL, SPECIAL, EXEMPLARY, OR CONSEQUENTIAL DAMAGES (INCLUDING, BUT NOT LIMITED TO, PROCUREMENT OF SUBSTITUTE GOODS OR SERVICES; LOSS OF USE, DATA, OR PROFITS; OR BUSINESS INTERRUPTION) HOWEVER CAUSED AND ON ANY THEORY OF LIABILITY, WHETHER IN CONTRACT, STRICT LIABILITY, OR TORT (INCLUDING NEGLIGENCE OR OTHERWISE) ARISING IN ANY WAY OUT OF THE USE OF THIS SOFTWARE, EVEN IF ADVISED OF THE POSSIBILITY OF SUCH DAMAGE.

❑ strlcpy-1.5

Copyright (c) 1998 Todd C. Miller <Todd.Miller@courtesan.com>
All rights reserved.

Redistribution and use in source and binary forms, with or without modification, are permitted provided that the following conditions are met:

1. Redistributions of source code must retain the above copyright notice, this list of conditions and the following disclaimer.
2. Redistributions in binary form must reproduce the above copyright notice, this list of conditions and the following disclaimer in the documentation and/or other materials provided with the distribution.
3. The name of the author may not be used to endorse or promote products derived from this software without specific prior written permission.

THIS SOFTWARE IS PROVIDED "AS IS" AND ANY EXPRESS OR IMPLIED WARRANTIES, INCLUDING, BUT NOT LIMITED TO, THE IMPLIED WARRANTIES OF MERCHANTABILITY AND FITNESS FOR A PARTICULAR PURPOSE ARE DISCLAIMED. IN NO EVENT SHALL THE AUTHOR BE LIABLE FOR ANY DIRECT, INDIRECT, INCIDENTAL, SPECIAL, EXEMPLARY, OR CONSEQUENTIAL DAMAGES (INCLUDING, BUT NOT LIMITED TO, PROCUREMENT OF SUBSTITUTE GOODS OR SERVICES; LOSS OF USE, DATA, OR PROFITS; OR BUSINESS INTERRUPTION) HOWEVER CAUSED AND ON ANY THEORY OF LIABILITY, WHETHER IN CONTRACT, STRICT LIABILITY, OR TORT (INCLUDING NEGLIGENCE OR OTHERWISE) ARISING IN ANY WAY OUT OF THE USE OF THIS SOFTWARE, EVEN IF ADVISED OF THE POSSIBILITY OF SUCH DAMAGE.

❑ tinyxml-1.0.6

Original code (2.0 and earlier)copyright (c) 2000-2002 Lee Thomason (www.grinninglizard.com)

This software is provided 'as-is', without any express or implied warranty. In no event will the authors be held liable for any damages arising from the use of this software.

Permission is granted to anyone to use this software for any purpose, including commercial applications, and to alter it and redistribute it freely, subject to the following restrictions:

1. The origin of this software must not be misrepresented; you must not claim that you wrote the original software. If you use this software in a product, an acknowledgment in the product documentation would be appreciated but is not required.
2. Altered source versions must be plainly marked as such, and must not be misrepresented as being the original software.
3. This notice may not be removed or altered from any source distribution.

❑ The Spotify software is subject to third party licenses found here:

www.spotify.com/connect/third-party-licenses

DENON[®]
www.denon.com

3520 10710 00AD
Copyright © 2019 D&M Holdings Inc. All Rights Reserved.

Downloaded from www.linephaze.com

- Find specs, manuals and used listings across thousands of audio products.